

Depth of Field Outside the Box

by Richard F. Lyon

<dicklyon@acm.org>

DRAFT of 4 April 2006 — for review only; do not distribute or cite

“Many photographers incline to despise theory altogether. I do not, by any means, wish to deny that the theoretical part of photographic work may be pushed too far to the detriment of practice, but I know very well that, in the matter of the optics of lenses, a very little theoretical knowledge increases greatly the capability of these instruments in the hands of a photographer.” — W. K. Burton 1891

But a very little theoretical knowledge can also be dangerous:

“Depth of focus, or depth of definition, is dependent upon the aperture and the focal length of a lens. It increases in the same ratio as the diameter of the aperture is reduced, and it diminishes as the square for any increase in the size of picture, or the focal length of lens.” — J. H. Dallmeyer 1874

And theoretical observations can appear to be mutually contradictory:

“At this point it will be sufficient to note that all these formulae involve quantities relating exclusively to the entrance-pupil and its position with respect to the object-point, whereas the focal length of the transforming system does not enter into them.” — M. von Rohr 1906

So let us investigate.

Abstract:

It is not necessary to know the focal length and f-number of a camera lens to compute a depth of field, and indeed formulas that use the “outside the box” parameters, field of view and entrance pupil diameter, may be easier to understand and reason with. The often confusing issue of how to choose an acceptable circle of confusion diameter is simplified in this approach as well, and is tied more simply to the resolution of human vision, typically as a nondimensional criterion such as 1/1500 of the image diagonal. Furthermore, this “outside” approach has solid historical support from the nineteenth and early twentieth centuries, deriving from the optical research of Ernst Abbe and Moritz von Rohr at Jena. As far as I can tell, however, this approach has never been fully and carefully articulated, and there is ample evidence of historical and modern-day confusions that it could help to clear up.

Introduction

The traditional way of computing depth of field (DOF) is complicated, and the formulae that describe it are not so easy to understand, especially when comparing different camera formats. This issue has recently generated a lot of discussion, since the formats of most digital single-lens reflex (DSLR) cameras are smaller than the “35-mm full-frame” format of the film SLR cameras that share their lens families. Here I describe another way to compute DOF, decoupled from camera format via field of view (FOV), and hopefully making the whole subject easier to understand.

The usual DOF equations are formulated in terms of focal length, f -number, maximum acceptable circle of confusion (COC) diameter, and subject distance. Typically, the COC criterion is taken to be proportional to the camera format size, such as format diagonal divided by 1500. For example, it is typical to use a blur diameter criterion of 0.029 mm for a 35-mm full-frame format with 43 mm diagonal, and proportionally smaller for “cropped” DSLR formats.

The alternative developed here ignores, or normalizes away, the focal length, f -number, format size, and *absolute* COC, and substitutes the *absolute* lens aperture diameter, the FOV, and either the *relative* COC or the *angular* COC. The viewpoint is entirely “outside the box”, looking at the camera as just an aperture with a field of view, independent of what’s on “the dark side”. The results differ from the usual formulae in some details, since FOV implicitly incorporates, and therefore hides, the lens-extension effect of close focusing; this hiding makes the results somewhat simpler, and easier to understand, but in need of some elaboration for macro focusing.

Subject versus Object: in this paper, I refer to the *subject* of the photograph, though it is more commonly called the *object* in writings on optics. This *subject* usage seems more *photographic* to me, rather than *optical*, and it lets me use the letter S for subject distance rather than O for object distance; d and D are too overloaded already for various distances, diameters, and diagonals.

Parameterizing the Picture

Let us define our terms, and their relationships to the more common terms:

$$w = W/f' \text{ — relative field-of-view width —}$$

W being the “inside the box” width of the field in the focal plane (the diagonal measure, typically), and f' being the distance from the lens to the focal plane (that is, the focal length f , extended somewhat for finite subject distance, and adjusted if necessary to agree with a thin lens or pinhole of the same field of view). This numerical width w can be considered to be an angle in radians, approximately, or twice the tangent of one-half the angle of view in the case of a rectilinear lens (for a fisheye the tangent would be infinite, so the angle is a better interpretation in that case). For a *normal* lens, w is about 1.0 (for a 50-mm lens on 35-mm full-frame camera, $w = 0.865$); w less than 1.0 is telephoto, or narrow field, and w greater than 1.0 is wide angle.

$$c = C/W \text{ — relative circle-of-confusion criterion —}$$

how small your “inside the box” C needs to be compared to W ; or how small your C on a print needs to be relative to print size, for your picture to be considered sharp. Values of 1/1000 to 1/2000 are

sometimes used, but $c = 1/1500$ is most typical when W is the diagonal width.

$$e = wc \text{ — angular confusion criterion (e.g. } w/1500) \text{ —}$$

the allowed angle of blur (in radians) as viewed from the lens looking into the scene; typically less than 1 milliradian (near 2 minutes of arc) for a normal lens. The conventional approach to choosing a C as a fraction of a print size is equivalent to taking an angular criterion, from the camera viewpoint, as a fraction c of the non-dimensional scene width w , which is what the angle e represents.

$$d = f/N \text{ — absolute aperture diameter —}$$

the lens entrance pupil absolute diameter for focal length f and f -number N .

The parameters w , c , and e are non-dimensional ratios, interpretable as angles in natural units of radians; diameter d is an absolute length, to be represented in the same units as subject distance, focal length, etc., so that the equations will remain in a natural form without conversion factors.

Figure 1 illustrates these parameters.

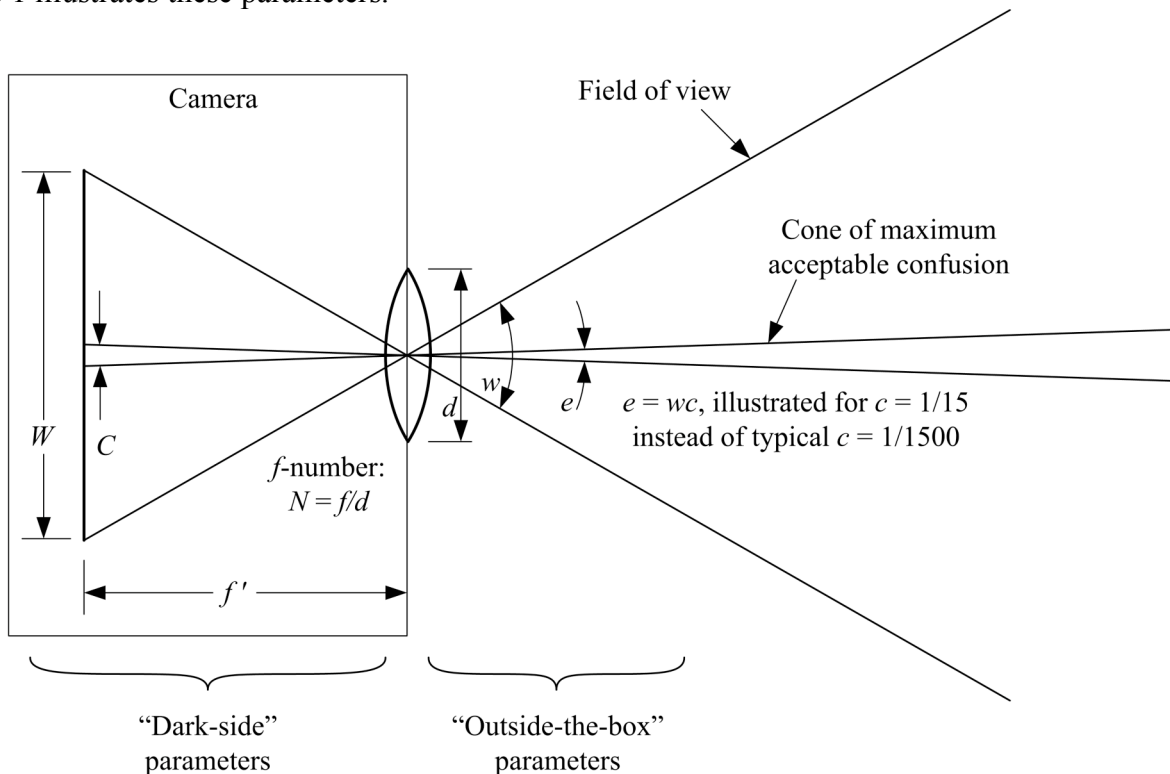

Figure 1. Diagram showing different parameterizations of a camera, to aid in depth-of-field calculations. For purpose of illustration, we exaggerate the acceptable blur by a factor of 100, taking c to be $1/15$ instead of $1/1500$, making the small angle e big enough to draw (drawn as about $1/15$ radian, or 3.8 degrees, for a normal lens, rather than the realistic 2.3 minutes of arc).

Finding Depth of Field

Camera parameters f , W , C , and N are now set aside; instead we use the “outside-the-box” parameters w , c , d , and e . The focal length and lens focusing relation $1/f = 1/f' + 1/S$ can be used to adjust w for close

focusing if desired, but are otherwise not needed in the calculations. In any case, the problems are these:

1. Find the nearest distance S_H at which the camera can be focused such that subjects at infinity are still acceptably sharp. This distance is called the hyperfocal distance.
2. Given that a subject at distance S is sharply in focus, find the near and far distance limits S_N and S_F for acceptably sharp imaging.

S : subject distance, or more precisely, the distance that is perfectly in focus
 S_N : near limit of focus
 S_F : far limit of focus
 S_H : hyperfocal subject distance; the value of S that makes S_F go to infinity

The problem is set up as shown in Figure 2, by projecting rays backwards, from the lens edges to the subject, converging at the subject distance S and separated by a varying subject-space COC diameter at all other distances. Rays from the edge of the lens define a “Near Cone of Confusion” as they converge toward the in-focus subject, and then a “Far Cone of Confusion” behind the subject, each with apex angle d/S . We draw the projected rays converging at the subject distance, without needing to look inside the box, by definition of focus and subject distance.

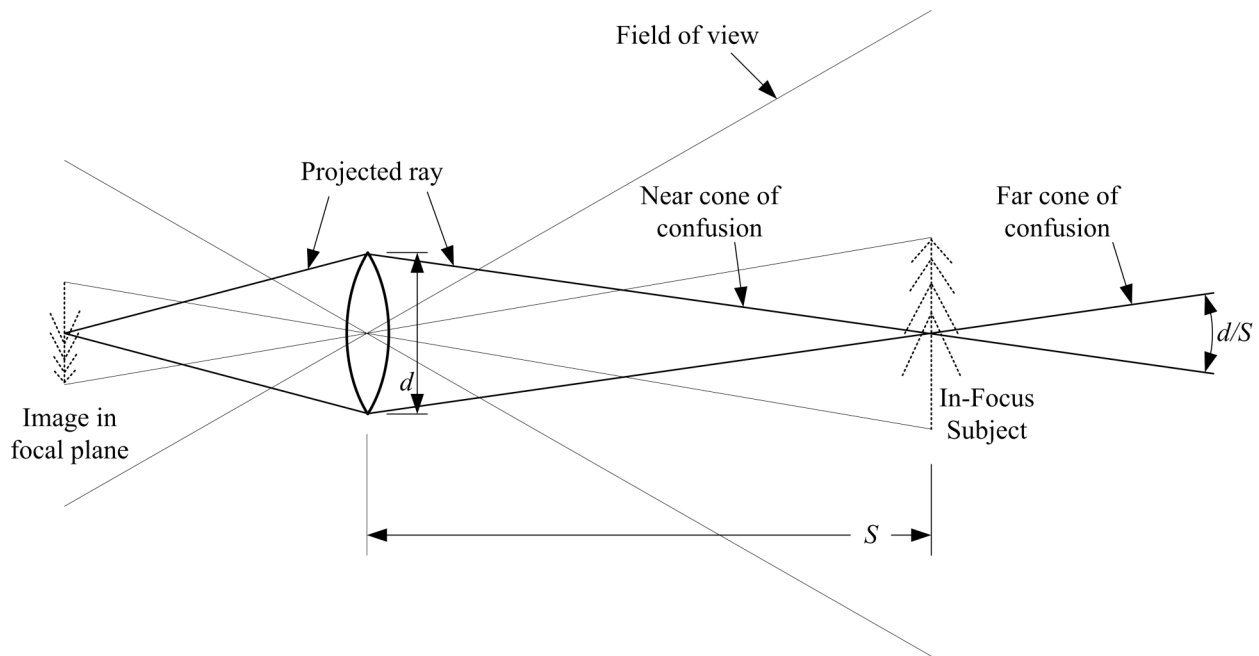

Figure 2. Diagram showing how rays can be projected “backwards” from a point in the focal plane, through the lens opening, to all distances in the subject field.

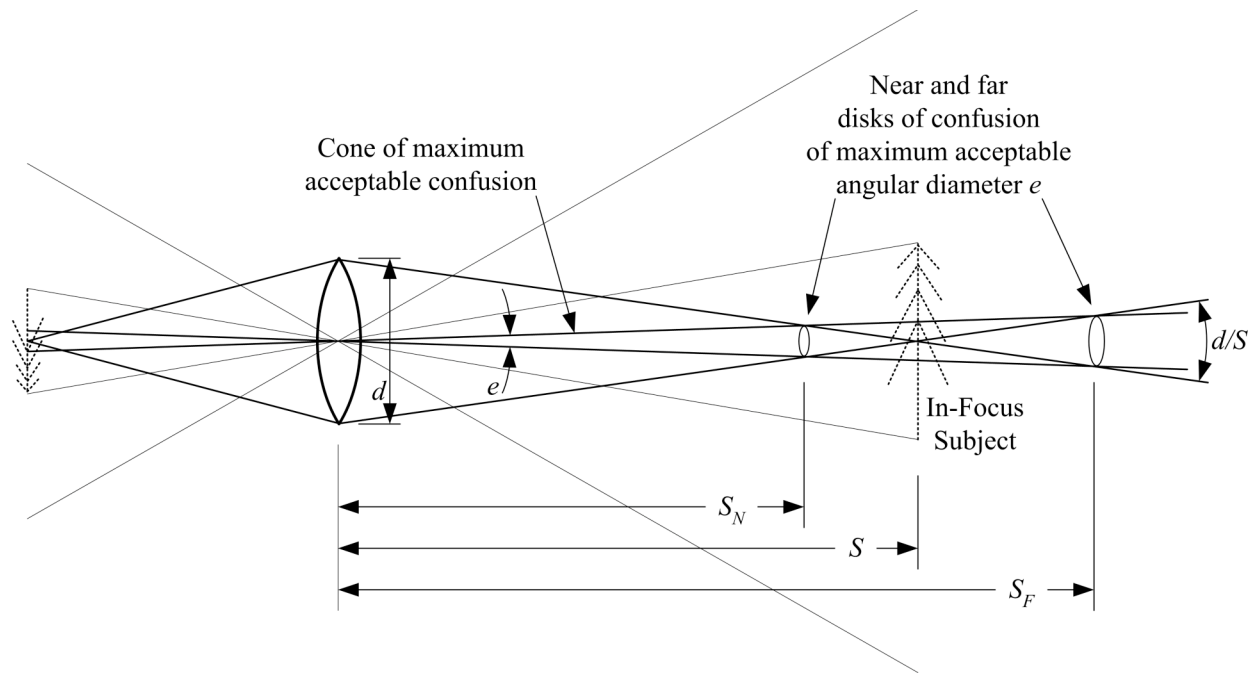

Figure 3. Finding near and far limits by intersecting the cones of confusion from Figure 2 with the cone of maximum acceptable angular confusion from Figure 1.

The cross section of a cone of confusion at any particular distance is a *disk of confusion*. The diameter of a disk of confusion, divided by distance, is the angular COC that needs to be less than e for the image to be considered sharp enough.

This method of projecting a point in the focal plane to cones and disks of confusion in subject space is a dual of the usual approach, which is to project subject points to circles of confusion in the focal plane. It gives an equivalent description of misfocus by showing what cones of points in the scene contribute light to each point in the focal plane.

The distances S_N and S_F are calculated by simple geometry and algebra, to be the distances that give an angular blur equal to the criterion e , as shown in Figure 3. We just solve for the intersections of the cones, which is where the near and far disks of confusion are as big as they are allowed to be, namely a fraction c of the field of view. As usual, for the small angles involved, we neglect the difference between an angle in radians and its tangent (working the problem using similar triangles gives an equivalent result). Accordingly, we see two ways of writing the diameter of each of the near and far disks of confusion, and write the two ways as equal:

$$\begin{aligned} (d/S)(S - S_N) &= eS_N \\ (d/S)(S_F - S) &= eS_F \end{aligned}$$

The distance solutions come out quite simple:

$$\begin{aligned} S_N &= Sd/(d + eS) \\ S_F &= Sd/(d - eS) \end{aligned}$$

Notice that the term eS is the angular COC criterion times subject distance, so it is the diameter of the allowed confusion at the subject. When it is required that it be small compared to the lens diameter d , you get near and far limits close to S , so not much depth of field.

By inspection of the denominator, we see that S_F goes to infinity when $eS = d$, that is, when the allowed blur at the subject is equal to the lens opening diameter, so the hyperfocal distance is:

$$S_H = d/e = d/(wc)$$

This formula for S_H is useful because it makes it clear that the hyperfocal distance depends only on the angular blur tolerance e and the diameter d of your lens opening (which is a simpler dependence than the traditional formulae involving camera size or COC, focal length, and f -number). The second form, $d/(wc)$, reminds us that the angular blur tolerance e depends on the field of view w and the relative blur tolerance c .

Algebraic Observations

In the traditional formulation, hyperfocal distance is given by $f^2/(NC) + f$. Recognizing that f/N is d , we can understand and get rid of the quadratic dependence on focal length, making it $fd/C + f$. But f is about W/w , consistent with the approximation of neglecting the small $+f$ term, and C is cW , so the W cancels and the hyperfocal distance reduces to $d/(wc)$. Hence, the new derivation is consistent with the old, within the approximation of neglecting lens extension from f to f' , or equivalently neglecting the $+f$ term.

For simplicity in what follows, let's define a normalized subject distance:

$$s = S/S_H \text{ — subject distance relative to the hyperfocal distance.}$$

No matter how you get S_F , S_N , and S_H , you can get simple relationships between them. In the usual formulation, you need to neglect the small correction for lens extension, while in our formulation they are “exact” because we have treated the width w , and hence angular criterion e , as parameters rather than letting them vary as a function of focal length with subject distance.

Once you have the hyperfocal distance, the near and far limits can be expressed in terms of only the subject distance and the ratio of subject distance to hyperfocal distance:

$$\begin{aligned} S_N &= S/(1 + s) \\ S_F &= S/(1 - s) \end{aligned}$$

The difference of the limits is the total depth of field:

$$\text{DOF} = S_F - S_N = S(2s/((1 - s)(1 + s))) \cong S(2s) = 2S^2/S_H$$

wherein the parenthesized part is a non-dimensional ratio that for small enough s is close to $2s$. Here s , the subject distance relative to Hyperfocal, must of course be less than 1 to yield a finite DOF, and must be much less than 1 for the $2s$ approximation to be accurate.

The distances might be best appreciated as purely non-dimensional ratios relative to subject distance:

$$\begin{aligned} S_N/S &= 1/(1 + s) = S_H/(S_H + S) \\ S_F/S &= 1/(1 - s) = S_H/(S_H - S) \end{aligned}$$

or their inverses, reciprocal distance limits relative to subject distance:

$$\begin{aligned}S/S_N &= 1 + s \\ S/S_F &= 1 - s\end{aligned}$$

In this reciprocal-distance space, the difference between near and far is very simple, but perhaps not very useful:

$$S/S_N - S/S_F = 2s$$

The fact that reciprocal distances behave “linearly” in optical focus problems is why the depth-of-field scales on a lens barrel are symmetric about the focus distance.

Four Regions

Consider four regions of subject distance relative to hyperfocal distance:

1. Hyperfocal and beyond: for a subject at distance S_H or greater (that is, $s > 1$), the DOF extends to infinity, and forward at least as much as half the subject distance.
2. Far: for subjects at a distance somewhat less than S_H , there is much more DOF behind the subject than in front of it. For example, when s is $2/3$, we find $S_N = 0.6S$ and $S_F = 3S$. The distance $2S$ behind is five times greater than the distance $0.4S$ in front.
3. Medium: for subjects at a distance of about $S_H/4$ to $S_H/2$, as typified by $S = S_H/3$, the DOF extends about twice as far behind the subject as in front of it. That is, at $s = 1/3$, we find $S_N = 0.75S$ and $S_F = 1.5S$, with exactly twice as much distance far as near. The sometimes-cited “rule of thumb” of twice as much in focus behind as in front is approximately true in only this region.
4. Near, or Macro: for subjects that are quite close compared to S_H , the DOF extends nearly equally behind and in front of the subject. In that case $\text{DOF} = S(2eS/d)$, with about $S(eS/d)$ in focus in each direction. The non-dimensional eS/d is much less than 1 in this region, so the depth is not much.

Different Formats

We can draw several conclusions about comparing depth of field across different camera formats. Here is a summary of relationships:

1. Taking a lens off of a given camera and putting it onto a new smaller-format camera has the same effect as cropping a negative, namely, it narrows the FOV. If the focal length and f -number are unchanged, then d is unchanged, but w and e are reduced by the format size factor, so the hyperfocal distance d/e is increased, and the DOF is *reduced* at a given subject distance. For this to make sense, you need to realize that a smaller negative needs more enlargement to make any given size print, and therefore the acceptable amount of blur is smaller when the negative is cropped.
2. In the same situation, if the subject is re-framed to occupy the same portion of the frame, by backing

the camera away from the subject, increasing the subject distance by approximately the format-size ratio, then the term $s = S/S_H$ is kept as it was in the larger camera. DOF is *increased* because the unchanged factors $1/(1 + s)$ and $1/(1 - s)$ are multiplying a now-larger subject distance S . Notice that since you move your viewpoint, you change your perspective; that is, your main subject at distance S fills the same portion of your frame, but near objects are relatively reduced and far objects relatively magnified compared to the original perspective.

3. Now suppose that instead of “zooming with your feet” by backing up, you change to a lens with a shorter focal length, to keep the subject framed the same as before, from the original viewpoint, and you also keep the same f -number; then, your perspective and FOV w are as in the original situation, and e is the same, but the aperture diameter d is reduced by the focal length ratio, which is the same as the format-size ratio. In this case, your hyperfocal distance d/e is decreased, and your DOF is *increased* for any given subject distance.

4. If you reduce the focal length as above, but fix the aperture diameter d by also scaling to a lower f -number by the same format-size factor, then d/e and S remain the same, giving you the *same* DOF. From the “outside-the-box” viewpoint, your camera is no different, as it has the same aperture diameter, same position, and same field of view. Its format doesn’t matter. You also get equal amounts of blur due to diffraction in this case, but likely worse aberrations in the smaller camera since it is working at a lower f -number.

Notice that changing to a smaller format can make your depth of field higher, lower, or unchanged, depending on what you keep fixed.

Also notice the relation between cases 2 and 3 (consider the new, smaller, camera only): the subject is framed the same way, the format is the same, and the depth of field is the same, but the focal length is different. More generally, the depth of field will be *unchanged*, as you vary the lens focal length on a given camera with a fixed f -number, so long as you also move your shooting distance to keep the same framing of a given subject (approximately, at subject distance sufficiently less than the hyperfocal distance). That is, the approximate total $\text{DOF} = 2S^2/S_H$ changes by an f^2 factor in both the numerator and the denominator.

All of these observations have been made before, but never all together, as far as I can find, and usually not with such simple relationship to the equations. Bob Atkins 2003 comes close in his list of five answers, but omits mention of f -number and aperture diameter, so is not complete or sufficiently clear.

Most traditional treatments of depth of field assume that the COC criterion C is a constant; that is, they do not consider the impact of different formats at all, and therefore state that the DOF only depends of focal length, f -number, and subject distance. Some recent treatments, motivated by “cropped-format” digital SLR cameras, have treated the idea that these cameras should use a smaller C , but they often fail to clarify the conditions under which the DOF will be greater or smaller than that of an “equivalent” full-frame 35-mm camera. The very notion of “equivalent” becomes more confusing than useful when people fail to clarify what they mean by it. For example, Bob Atkins says

“For an **equivalent field of view**, the EOS 10D has at least 1.6x **MORE** depth of field that a 35mm film camera would have – when the focus distance is significantly less than the hyperfocal distance (but the 35mm format need a lens with 1.6x the focal length to give the same view).”

But he doesn’t specify that he is keeping f -number constant, and therefore changing the aperture

diameter, to get this result. Keeping the aperture diameter constant would have kept the **SAME** depth of field, but that alternative was not considered.

Macro Range: Correcting for Lens Extension

I did some sleight of hand, or approximating, in ignoring the fact that f' and hence the angular field of view w do not remain constant as the lens is focused to different subject distances. We used $w = W/f'$ and $e = cw$, propagating an implicitly fixed value of f' into our computing of S_H , S_N , S_F , s , etc. It is usually accurate enough to use f for f' except when S is less than about $10f$, at which point the error is about 10%.

When we shoot close-ups, f' is significantly greater than f . At 1:1 macro range, the subject and the focal plane are equally distant from the lens, at twice the focal length, $f' = 2*f = S$, making a factor of two error in the field of view w and hence in the angular blur criterion e that we used. We overestimate DOF by about 100% if we base it on this e , or on s without correcting the S_H we use.

Close-up correction is the one part of the DOF computation that needs more than the “outside the box” parameters. We need to know f to see how much correction is needed. The rule for focus tells us that $1/f = 1/f' + 1/S$. Solving, we get $f' = 1/(1/f - 1/S) = fS/(S - f)$, which differs from the focal length via the ratio $f/f' = 1 - f/S$. That’s the correction we need. Just multiply the w and e , or divide S_H , by $1 - f/S$ to get a corrected answer with somewhat reduced DOF. At 1:1 macro, $S = 2f$, so we get a correction factor of 0.5. The correction factor never goes to zero, because S must always exceed f .

The hyperfocal distance “corrected” to $S_H/(1 - f/S)$ is not really a hyperfocal distance any more, but is a number that makes the formulae in terms of $s = S/S_H$ give an exact answer for a particular subject distance. The hyperfocal distance itself is usually much greater than $10f$, so correcting it is not usually necessary; but if you want it corrected, dividing S_H by $1 - f/S_H$ is essentially equivalent to just adding f to S_H .

In the macro range, the approximation in neglecting the small asymmetry in total depth of field is negligible:

DOF = $S_F - S_N = 2S(S - f)/S_H$ almost exactly, needing no further correction to the hyperfocal distance

Notice that the DOF gets very small for extreme closeup shooting, where $S - f$ tends toward zero. Stopping down to make S_H very large will help until the diffraction blur from the small aperture gets to be as big as the acceptable circle of confusion. One more problem that may make this approach inexact is that complex multi-element lenses sometimes will change their focal length when focused close up.

Using Magnification

Some authors rely on the magnification $m = f'/S$ between subject and image in their DOF calculations. As long as we recognize that m will scale with camera format size and C when comparing different cameras taking the same picture, these can be sensibly interpreted.

The magnification relates the diameter of the focal-plane criterion C to the acceptable blur diameter C_S

at the subject distance or “field plane”:

$$C_S = C/m = eS$$

In the macro realm, and especially for $m > 1$, an alternative to the correction ratio $f/f' = 1 - f/S$ is its reciprocal ratio $f'/f = 1 + f'/S = 1 + m$. That is, when a lens is focused to give a magnification of m , the extra extension needed is a factor of m beyond the focal length. At that point, the subject distance is given by $S = f(1+m)/m$, the distance to the focal plane is $f(1+m)$, and the two of these together satisfy the lens equation $1/f = 1/S + 1/f'$. But with a strictly outside-the-box approach, we can ignore the focal length and these distances, and just use magnification to get the circle of confusion limit at the subject, for the simplest possible general depth formulae:

$$S_N = Sd/(d + C_S) = Sd/(d + C/m)$$

$$S_F = Sd/(d - C_S) = Sd/(d - C/m)$$

with the usual macro approximation for $C/m \ll d$:

$$\text{DOF} = S_F - S_N = 2SC_S/d = 2SC/md$$

which works in general for C measured in the focal plane or a print, and m measured to the corresponding point. With a little algebra, substitution of f-number $N = f/d$, and use of effective f-number $N' = N(1+m)$, we get the total depth-of-field back in “dark side” terms:

$$\text{DOF} = 2CN(1+m)/m^2$$

$$\text{DOF} = 2CN'/m^2$$

which only make sense for C measured in the focal plane and m being camera magnification, from subject to focal plane. In many cases in photomacrography, the key parameter is magnification to a standard-size print (e.g. 300 mm diagonal or 8x10 inch), with a print COC criterion such as $C_P = cW_P = W_P/1500 = 0.2$ mm. The total magnification m_t includes factors of both camera magnification m_C and enlargement m_E , so the blur criteria are $C = C_P/m_E$, $C_S = C_P/m_T$.

$$\text{DOF} = 2C_P N'/m_C m_T = 2C_P N(1 + m_C)/m_C m_T = 2C_P N(m_E + m_T)/m_T^2$$

What this expression means is that if we want to involve the f-number of the lens in the DOF calculation, we need to know the camera magnification, not just the total magnification to the print. This formula has first published by Ted Clarke in 1984. H. Lou Gibson adopted the same in 1986, correcting his earlier not-quite-right formulae in Kodak technical publications from the 1970s. A formula that looked like $2CN(1+m)/m^2$ was published by Bracegirdle in 1995, but he called N the *effective* f-number [his italics], when it must really be the *nominal* f-number; his magnification can not include enlargement.

There is one further complication that makes this whole approach suspect for non-symmetric lens designs: we took magnification to be a ratio of distances from the lens, or from the pupils, but actually it should be the ratio of distances from the principal planes. For non-symmetric lenses with non-unity pupil magnification, at close subject distances, further corrections are needed, as established in an online article by Paul van Walree, 2003. The formula $2SC/md$ is exact, as long as S is measured from the entrance pupil, but the equations with N may need adjustments.

Gleichen observed in 1911 (1921 translation), in a section titled “New Expression for the Depth of Focus:”

“Thus, if a certain value for $[C]$ be agreed upon and the objective aperture and magnification are given, then for a given distance...of the object, the object-space depth is fixed. **The type of objective and its focal length are quite immaterial, having no effect on the object-space depth**; thus the depth for a tele-objective is the same as for any other objective whose entrance pupil coincides with that of the tele-objective.” [Gleichen’s bold emphasis]

It would appear that the focal length is already completely determined by the object distance and the magnification, so it seems strange to call it immaterial. However, the immediately preceding section was on enlargement, so I think the correct more liberal interpretation is that the magnification referred to is the net magnification from object to enlarged print, since fixing the COC limit on the enlargement is more sensible than fixing it on the negative, as he already explained. Then, the focal length is immaterial as long as object distance is measured from the input pupil, aperture is an absolute measure, and the negative is enlarged to a given print magnification; it all makes good sense as an “outside the box” interpretation. He uses 1 minute of arc in the object space as his COC limit, corresponding to $e = 0.00029$, a value that he uses explicitly in his examples; this limit is very tight.

Microscopy, Photomacroscopy, and Trigonometry

In microscopy, we have the situation that the magnification is much greater than 1, so the subject distance is close to f . We have the further complication that the virtual image in the microscope is viewed by the eye, which can accommodate to focus at different distances. That is, the virtual image is in a three-dimensional space such that we get an extended depth of field by allowing the eye to focus at different depths; this extra depth is known as accommodation depth. For photomicrography and photomacrography, on the other hand, we capture only one plane, a real image, onto film or a digital sensor. I restrict my further remarks to the latter case.

A commonly cited formula for the DOF of microscope is

$$\text{DOF} = \lambda n / \text{NA}^2$$

where λ is the wavelength of light, and $\text{NA} = n \sin u$ is the “numerical aperture” of the objective, n is the index of refraction of the medium being imaged through (air, water, or oil), and u is the angle of the edge of the input pupil from the optic axis as seen from the subject. This formula seems to derive from Abbe, though I haven’t found an exact source. Many variations on the expression, with factors of 0.5 or 0.61, or $\sqrt{n^2 - \text{NA}^2}/n$, among others, are also found, for various reasons that we might understand shortly.

Let us deconstruct this expression. First notice that the n in the numerator is really only there to cancel one n from the denominator. The numerical aperture is a measure defined by Abbe for the purpose of computing the diffraction-limited resolution of a microscope. He concludes that for two points to be resolved, they need to be separated by at least about $0.61\lambda/\text{NA}$. This value is also derivable from the Rayleigh criterion, which says that the spacing between points needs to be at least equal to the distance from the center of the diffraction blur Airy disk to its first null. The DOF formula would make a lot more sense, especially for our purposes, if Abbe had left the index of refraction out of the numerical aperture definition and used it to correct the wavelength instead, giving a resolution of $0.61/\sin u$ in units

of the modified wavelength λ/n in the medium of interest.

This approach to the microscope's DOF is driven by the diffraction-limited resolution limit of the objective, rather than by the angular visual acuity of the eye. The eye's visual acuity comes into calculating how much magnification is needed to get the resolved detail to a scale where the eye can resolve it, and not too much bigger where it would be just a blur.

If we take for the subject-space circle-of-confusion criterion C_S a diameter a bit larger than the resolvable distance between points, namely $(\lambda/n)/\sin u$, then we can rewrite the DOF as

$$\text{DOF} = C_S/\sin u$$

which is clearly incorrect in terms of geometric optics, and should really be

$$\text{DOF} = C_S/\tan u = \lambda/(n \sin u \tan u)$$

Among the experts who have commented on this discrepancy are Dippel 1882 and Czapski 1893, yet it is still commonly used. It overestimates the DOF only for large numerical apertures (f -numbers less than 1). In some books, the factor $\sqrt{n^2 - \text{NA}^2}$ is used in the numerator instead of the simple n . This factor is more easily understood once you see it is $n \cos u$, or exactly the factor needed to convert the $\sin u$ to $\tan u$.

The C_S in this formula is in the object plane, our eS ; the C in the image plane will be m times larger. It matches our previous two-sided macro result: $\text{DOF} = S(eS/d)$, where $2S/d$ is exactly $\tan u$ if S is measured from the entrance pupil.

Czapski 1893 says in reference to Abbe's use of the sine "Diese Formel weicht von derjenigen, die von Abbe angegeben und nach ihm von den meisten anderen Schriftstellern ueber diesen Gegenstand wiederholt worden ist darin ab, dass hier die trigonometrische Tangente auftritt, wo in jenen der Sinus. Die Differenz erklart sich aus einer strengeren Ruecksichtnahme auf die Voraussetzung des Aplanatismus fuer die scharf eingestellte Ebene. Macht man diese Voraussetzung nicht, so laesst sich ueber den Zerstreuungskreis ueberhaupt nichts mehr feststellen—ausser wen der Winkel u so klein ist, dass \sin und \tan nahezu gleich gross sind." (approximately: This formula yields of that, those of Abbe indicated and after it of most other writers over this article repeated is in the fact off that the trigonometric tangent arises here, where in those the sine. The difference explains itself out of a stricter consideration for the condition of the aplanatic lensism for the sharply stopped level. If one does not make this condition, then nothing at all more can over the scatter circle be determined—except whom the angle u is so small that sine and tangent are almost equivalent large.)

The tangent, however, causes the DOF estimate to approach zero too rapidly as the angle u approaches a right angle. A 1993 paper by I. T. Young *et al.* presents a different approach to the diffraction-limited DOF of a microscope, using wave methods instead of geometric ray methods. The depth criterion is a maximum wavefront difference of a quarter wavelength, to get an image that's close to the diffraction-limited ideal. The result looks complicated because they write it in terms of NA, backing out the refractive index and converting the sine to a cosine using a square root of one minus the square. And they give a formula for a one-side DOF, instead of the total DOF. Writing it instead in terms of the angle u , and converted to double-sided DOF, it looks simple enough:

$$\text{DOF} = \lambda/(2n(1 - \cos u))$$

It is easy to verify that this formula splits the difference between the conventional $\lambda/(n \sin^2 u)$ and the geometrically motivated $\lambda/(n \sin u \tan u)$, approaching a half wavelength rather than zero or a full wavelength, for u near a right angle. For small u , where $1 - \cos u$ is very nearly $u^2/2$, all of them are very close to $\lambda/(n u^2)$, which is also a good middle road for large u , approaching about 0.4λ for $u = \pi/2$. For any situations other than microscopy, these differences between the formulae are negligible.

The DOF is less, of course, for smaller choice of COC limit, and choosing the subject space COC equal to the resolution, or a little less, namely $0.61\lambda/NA$ or $0.5\lambda/NA$, is not uncommon.

Clarke's Optimum Aperture Formula

We mention these topics from diffraction-limited photomicrography primarily because they can also apply to photomacrography. Keep in mind that stopping down to get more DOF is counterproductive if it makes the diffraction-limited resolution as bad as or worse than your desired COC limit. For example, with a full-frame 35mm-format camera, $C = 0.029$ mm, make sure that $1.22N\lambda$ is significantly less than 0.029 mm. So for $\lambda = 0.00055$ mm (green light), the effective f-number N should be 32 or lower. At 1:1, that means the f-stop of the lens should be set at 16 or lower. For stricter sharpness goals, larger magnifications, or smaller camera formats, the f-number must be lower to avoid diffraction problems. Clarke 1984 (or see Delly 1996) derives the formula $f\text{-number} = 220/(m_T + m_E)$ as the aperture setting that maximizes DOF consistent with a given desired magnification and 6 line pairs per mm resolution on a print (the print size doesn't matter here, but 6 lp/mm is a typical criterion for a 300 mm print at a minimum viewing distance of about 250 mm). The 220 in this formula is, within a small fudge factor, the ratio of the desired final COC diameter or resolution to the wavelength of light (e.g. $0.147\text{mm}/0.00055\text{mm} = 268$).

Let us see what Clarke's formula does to DOF and resolution, using our previously derived DOF formula (which is also Clarke's own):

$$\text{DOF} = 2C_P N (m_E + m_T) / m_T^2 = 2C_P (220 / (m_T + m_E)) (m_E + m_T) / m_T^2 = 440 C_P / m_T^2$$

Since the DOF is also given by $2SC_P / m_T d$, we must have

$$2S/d = 440/m_T$$

Using $1/\tan u = 2S/d$ and neglecting the difference between sine and tangent again, the Numerical Aperture is approximately $\sin u = m_T/440$, and the Rayleigh-criterion resolution at the subject is therefore

$$0.61\lambda/\sin u = 268\lambda/m_T$$

so the resolution at the enlarged print is 268λ , or 0.147 mm for green light. A C_P of about the same size makes sense, in which case the COC limit at the subject is the same as the subject resolution:

$$C_S = 268\lambda/m_T$$

which finally yields the DOF in terms of magnification at optimum f-number as

$DOF = C_S/\tan u = 440 \cdot 268\lambda/m_T^2 = (343/m_T)^2\lambda = 0.61(440/m_T)^2\lambda = 0.61\lambda/NA^2$ (in agreement with the traditional range, but we restrict ourselves to air, $n = 1$).

Therefore the DOF only depends on the total magnification, when COC is matched to resolution, and resolution is fixed on the print by the proper choice of aperture according to Clarke's formula (or, equivalently, by Abbe's criterion that gives the needed NA). The DOF in wavelengths is just the square of the ratio of 343 to total magnification. For DOF less than a wavelength, or magnification greater than 343, where the difference between sine and tangent is not negligible, this result is probably not very accurate, but for photomacrography it should be fine.

For example, with 20X magnification to a 300-mm print, you can get total DOF of $(343/20)^2\lambda = 294\lambda = 0.16$ mm, with subject resolution $268\lambda/m_T = 268\lambda/20 = 13\lambda = 0.0074$ mm, independent of camera format and focal length. To achieve that 20X via 12X enlargement from a DSLR sensor, with 5/3 magnification in the camera, choose f-number $N = 220/(20 + 12) = 6.9$; this f-number depends on the format, but not on the focal length. The resulting absolute aperture diameter and subject distance depend on both focal length and format (or enlargement factor, or camera magnification).

The above is my understanding of Clarke's optimum aperture formula, relating a simple "outside the box" interpretation involving only the total magnification to a more traditional interpretation involving several distinct magnifications and a camera's f-number. If the COC is taken as somewhat larger or smaller than the resolution, it will change the DOF calculated, but not the Rayleigh-criterion resolution and optimum aperture as derived above.

The constant 220 was derived by Clarke from a combination of theoretical and careful experimental evaluations, for the case of 6 line pairs per mm desired resolution on the print (nominally 0.167 mm, interpreted as 0.147 mm Rayleigh criterion convolved with some focus blurring up to 0.147 mm COC). In terms of the desired COC on the print, the more general factor (to replace the 220) would be (with C_P in mm): $220C_P/0.147 = 1500C_P = 0.82C_P/\lambda$; or in terms of resolvable point separation R (in mm), use $220R/0.167 = 1320R = 0.72R/\lambda$.

Choosing the COC Criterion

The idea of choosing the maximum permissible COC as proportional to the format size is fundamental to our approach of ignoring the "dark side," but it has not always been the approach selected by others. In fact, the choice of COC criterion has been, in my opinion, an area where most past experts have done a disservice by sweeping it under the rug or treating it too narrowly. Even Merklinger (1990), who treats different format sizes and discusses the choice of COC at length, didn't ever quite say it should be proportional to format size or to print size. His treatment of diffraction effects and film curvature did more to muddy the picture than to clarify it, in my opinion.

Abney (1881–1905 editions) discusses an angular criterion:

"The aperture of the diaphragm also determines the amount of depth of focus, and this increases as the diameter of the aperture diminishes. Any point which is out of focus is represented by a disc of confusion, and when such a disc does not exceed a certain diameter, the eye is unable to distinguish it from a point. In practice 1 minute of arc is taken as the limit. When the diameter of this disc, as viewed from an ordinary distance for examining a picture (40 to 50 centimetres) subtends more than a minute of arc, the object will appear to be out of focus, whilst if less it will be in focus. Hence we may argue that

the smaller the aperture of the diaphragm the greater the depth of focus there will be, since the foci of nearer objects and distant ones may all be made to fall within this limiting angle by diminishing it.”

One minute of arc at 45 cm is about 0.013 cm on the print, but he states that it is about 0.025 cm, and that’s what he uses. It would be consistent with 1/1500 of the image diagonal if the diagonal of the print is about 20 cm for 0.013 cm, or 38 cm (a very large plate) for his 0.025 cm COC. So, he’s in our ballpark at least, with approximately one to two minute of arc acceptable angular COC.

Many writers before the age of the “miniature” (35 mm) camera use 0.1 mm, or 1/100 or 1/200 inch, for the permissible COC diameter on the negative. For 35 mm, 1/30 mm, 0.03 mm, and 0.029 mm are typical. The 1937 paper “Depth of Focus in a Nutshell” uses 1/240 inch, 1/480 inch, and 1/720 inch for quarter-plate, 2¼ inch, and 35 mm cameras, respectively (approx 1/10 mm, 1/20 mm, and 1/30 mm respectively), which seems like a step in the right direction (the particular numbers chosen are to make the formulas in feet and inches work out most easily).

Hardy and Perrin (1932) produced a table of near and far depth of field (that is, $S - S_N$ and $S_F - S$) independent of focal length and with only two parameters, magnification and f -number; they showed that using magnification is equivalent to measuring subject distance in multiples of focal length (that is, $1/m = S/f - 1$). To get to only two parameters, however, they had to ignore the dependence of COC criterion on format size, contrary to their preceding discussion of using smaller COC for smaller formats, and used simply 0.1 mm diameter, “which is ordinarily the smallest image of a point that can be obtained with a well-corrected objective.”

Greenleaf in 1950 used 0.25 mm as COC criterion on the print, for viewing at “normal reading distance.” He goes on to say that for enlargements, that means the COC in the negative must be correspondingly smaller. So he has effectively worked format size into the COC, but he hasn’t said anything about the actual print size for which 0.25 mm is appropriate, or whether he would allow a larger COC on a bigger enlargement. The notion of tying COC to the format diagonal is not there yet.

Cox in 1966 discusses using “the actual size of the disk of confusion, rather than using a formula to give its size implicitly” (e.g. as $f/1000$). He mentions 0.002 inch or 0.0015 inch for “35 mm double frame work,” 0.001 inch for 35 mm and 16 mm cine work, and 0.0008 inch for 8 mm movie camera. These are not quite in proportion to format size, but at least they vary in the right direction. His numbers are complicated by the fact that these movie formats correspond to very different expectations about sharpness and resolution. In a later chapter of his book, however, Cox goes back to an effectively format-relative criterion via the “normal” lens, saying, “we should use the size of the circle of confusion related to the focal length of the camera lens which would normally be used.”

A common tradition has been to use $f/1000$ as the COC criterion. Horder (1958 and 1971) has a whole section “Permissible diameter of the circle of confusion in prints and negatives” explaining this approach based on “correct” viewing conditions and contrasting it with the diagonal/1000 approach based on “comfortable” viewing conditions, which

“... gives, on average, results nearer to practical experience. ... Both sets of formulae break down, however, in face of the visitor to an exhibition who goes right up to the photo mural to detect signs of retouching. But then, his viewing conditions are neither correct nor comfortable!”

In his conditions of permissible COC diameter on a print being “1/1000 of diagonal of print,” Horder points out that on the negative that corresponds to “1/1000 of diagonal of that portion of negative used to

make print.” This suggested dependence of DOF on cropping anticipates what we need to understand about the DOF of cropped-format DSLRs, namely, that cropping by itself inherently changes the DOF.

Perhaps Horder’s 1958 edition is the origin of what I take to be the modern convention, though it has since been tightened up, from 1/1000 to 1/1500 of the diagonal.

The 1975 first edition *Kodak Professional Photoguide* includes a set of DOF calculators for medium- and large-format cameras; analyzing them, I find that their criteria are consistent with c values in the range 1/1100 to 1/700, generally looser than other sources, but with COC more nearly a fraction of format diagonal than of focal length.

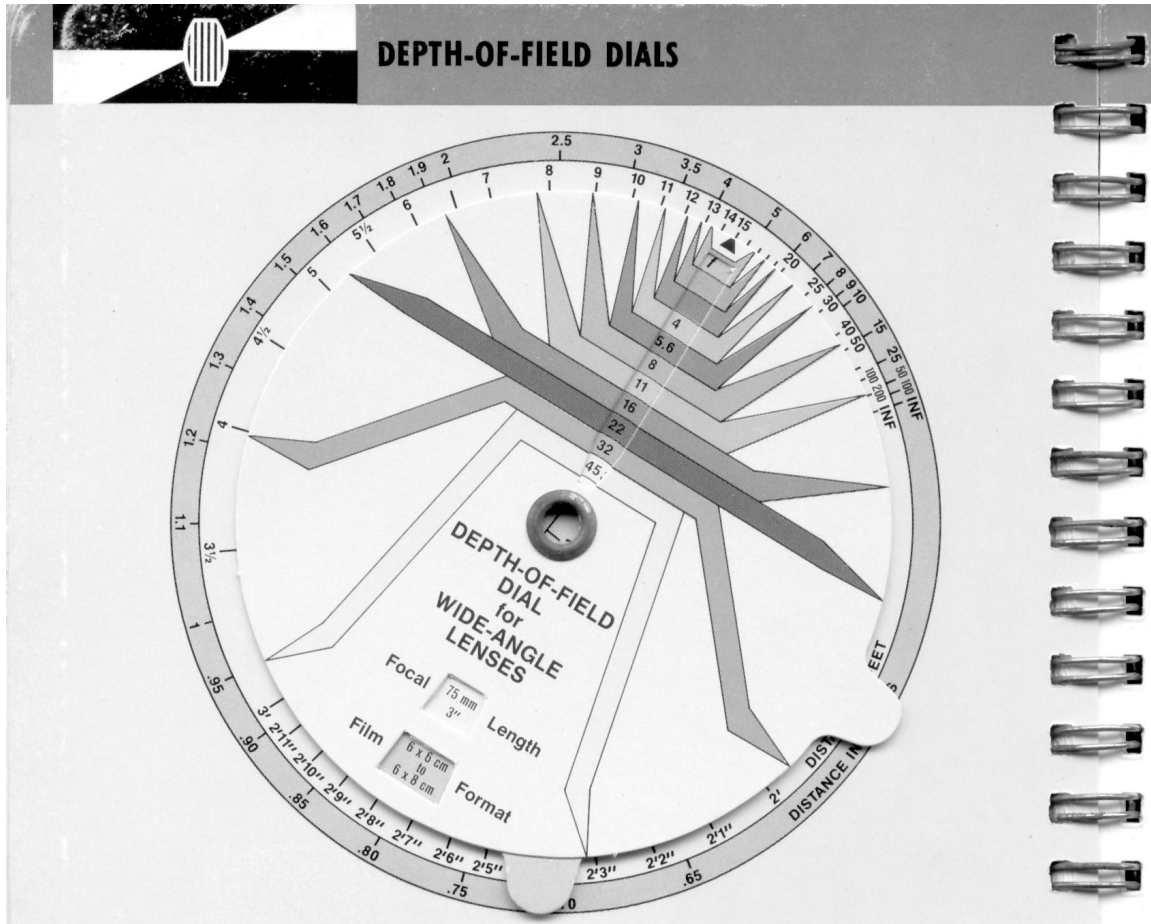

Figure 4. A DOF calculator for wide-angle lenses from the 1975 *Kodak Professional Photoguide*. Notice that it can only be accurate to the nearest whole stop, and that it gives the same result in many cases for 6x6 and 6x8 formats (diagonals 79 and 93 mm respectively). It shows hyperfocal distance $S_H = 5\text{m}$ for $f/11$ with 75 mm lens, or $d = 6.8\text{ mm}$. Using Horder’s $c = 1/1000$, with the two w values 1.05 and 1.24, we get for hyperfocal distance $d/(wc)$ the values 6.5 m and 5.5 m respectively, slightly less optimistic than Kodak’s estimate.

The so-called “correct” viewing conditions are those that make each object in the scene cover the same angle in the eye of the viewer as they would have in the original scene. As Mitchell (the editor of the earlier, second through fourth, editions of *The Ilford Manual of Photography*) explains it, “It is generally assumed that prints will be examined at about 10 ins. from the eye, and that at this distance image disks not more than 1/100th of an inch in diameter are not distinguishable from points. If we assume that the

print has been made (by contact or in the enlarger) to give correct perspective when examined at 10 in., then we can express the diameter of the circle of confusion in terms of focal length of the taking lens, that is to say, as $f/1000$.” The only trouble with this logic is that nobody makes prints this way—we don’t strive for “correct perspective” because that would force us to print telephoto shots very small and wide-angle shots very large. That strategy would largely defeat the point of our lens choice, which is often to distort the “correct” angle of view, to bring far objects close or allow an exaggerated perspective.

This idea of a “correct” viewing distance was very strongly held by some nineteenth-century writers such as W. K. Burton (1891) who said:

“If it be wished that ‘the distance’ appear quite sharp when the picture is viewed from a distance equal to the focal length of the lens—that is to say, from the distance about that any intelligent person would select for looking at it from—the diameter of the stop must not be larger than $1/2000$ of the distance of the object focussed for.”

Burton’s is a practical twist on the outside-the-box hyperfocal distance calculation, as it tells how to find the aperture diameter needed to get the subject distance to be the hyperfocal distance, with $e = 1/2000$. His notion of “quite sharp” may be a recognition that the usual “sharp enough” concept in DOF is not what you want for “the distance” in a landscape shot; one could for example interpret this his advice as $e = 1/1000$ and a recommendation to set the focus position of the lens to halfway between the infinity position and the hyperfocal distance. His explicit formula for hyperfocal distance, on the other hand, has a dark-side COC criterion of $1/100$ inch built into it.

Kingslake (1951) also supports this “correct” approach:

“...we shall assume first that the final print is always to be viewed from its correct center of perspective. This is the most desirable viewpoint under any circumstances, so it is not unreasonable to assume its adoption when we attempt to define the acceptable amount of depth of field in a given photograph. ... This very important concept provides the basis for the whole theory of depth of field...”

By this approach, Kingslake adopts an angular criterion $e = 1/1000$, corresponding to $C = f/1000$. Nevertheless, later in the chapter he considers using a fixed COC in the focal plane, such as 0.050 mm for 35 mm format, which agrees with the other approach only for the 50 mm normal lens. He provides a table of fixed COC values for different formats up to “small folding cameras,” roughly proportional., but then switches to $f/1000$ for large cameras, presumably because he expects prints from large cameras to be made without enlargement, and viewed from a distance equal to the focal length. Personally, I think this approach is very peculiar, and not so useful, and I wonder why it lasted as long as it did.

Ray (1979) says “A widely used criterion for C has been $f/1000$ but recently a fixed value of .05 mm or even .033 mm has been used for a complete range of lenses, notably by Zeiss.” But he does not discuss coupling the COC criterion to format size. The 0.033 Zeiss criterion, for 35mm-format cameras, corresponds to our system with $c = 1/1300$, less stringent than today’s typical .029 mm or $c = 1/1500$.

Norman Koren has an excellent tutorial page on Depth of Field and Diffraction, except that his formulae are overly complicated due to the use of the conventional approach. On the COC, he observes, “But inertia prevails: 0.01 inch is universally used to specify DOF,” meaning for the COC limit on an 8x10 print. That’s about $1/1280$ of the print diagonal, or $1/1440$ of the diagonal of the 35mm film negative that enlarges to 8x12 inches to be cropped to 8x10. That’s 0.030 mm on the film, and is indeed a

commonly cited value, along with 0.033 and 0.029.

COC and Megapixels

Another possible system in the age of digital cameras is to couple the COC criterion to the pixel-level resolution of the camera. Doug Kerr, in a 2004 web article on DOF, distinguishes this approach as the “camera resolution outlook”, as opposed to the scheme we’ve been using up to now, which is essentially what he calls the “visual acuity outlook.”

To pick a relationship between COC size and pixel size, let’s take for example a COC whose area is equal to the area per chroma sample in a Bayer-pattern sensor, i.e., four square pixels. This much blur is a little more than the amount typically provided by the anti-aliasing filter, and is enough to make a noticeable but not large reduction in sharpness. The diameter C is then 2.25 pixels. Relating this to the sensor diagonal and pixel count implies that we should choose:

$$c = 1/[0.64 \sqrt{\text{pixel_count}}] \text{ for 4:3 aspect ratio (and close enough for 3:2 and square)}$$

For example, a 2000x3000 (6 MP) camera would use $c = 1/1570$ and a 5.5 MP camera would use $c = 1/1500$. In general, cameras with more megapixels would use a tighter COC limit c , and consequently would have a tighter DOF by this approach.

Of course, if one is after more resolution, whether by more megapixels, finer grain, or a larger format, then using a tighter c makes perfect sense, and DOF must be less to satisfy that higher resolution requirement. For large-format large-print landscapes, a criterion of $c = 1/3000$ would be perfectly reasonable, corresponding to the high-end 22 MP digital medium-format cameras available today. Using such a camera with $c = 1/1500$, that is, tolerating a blur diameter of 4.5 pixels, would seem to be pointless.

For Foveon X3 or other “direct” color sensors, the same formula makes perfect sense if you count all three layers of pixel sensors in the pixel count. For example, for the Sigma SD10, with 10.2 MP, use $c = 1/2000$; at this point, the C is about 1.3 times the pixel size, or big enough to cause a noticeable but small loss of sharpness. If you prefer to count just pixel locations, then the formula changes its coefficient by a square root of three to become:

$$c = 1/[1.11 \sqrt{\text{location_count}}] \text{ for direct image sensor full-RGB or monochrome location count}$$

Alternatively, to be consistent with the relative luminance resolution compared to the Bayer sensors, or COC area equal to twice the luminance resolution-element area, loosen up from these formulae by $\sqrt{3/2}$ to get a COC diameter of 1.6 pixels:

$$c = 1/[0.91 \sqrt{\text{location_count}}] \text{ for direct image sensor full-RGB or monochrome location count}$$

By this formula, the Sigma SD10, with 3.4 M pixel locations, would use $c = 1/1670$, since it has the same luminance resolution as a 6.8 MP Bayer-pattern sensor that captures 3.4 M luminance samples. But the $c = 1/2000$ number is more in line with the Sigma fanatics’ and black-and-white lovers’ typical quest for sharpness.

In general, the choice of c must be left to personal preference; but understanding how it relates to your resolution goals, and how it affects your DOF, should be useful. The bottom line is as observed by Piper in 1901, after using 1/100 inch for all his examples, tables, and formulae: “The circle of confusion...should be varied solely in accordance with the necessities of the work, without following any arbitrary rules.”

Examples

[Try to make some good examples of what these different levels of misfocus look like at pixel level.]

The “Zeiss Formula” is Apocryphal

Several hundred web pages tell you: “Using the ‘Zeiss formula’ the circle of confusion is calculated as $d/1730$ where ‘ d ’ is the diagonal measure of the film in millimeters.” As of January, 2006, Wikipedia even dignifies it with “industry-standard” in front of “Zeiss formula.” Through extensive research (i.e., Google and the Internet Archive), I have determined the origin of this formula, including the unnecessary appendage “in millimeters;” it has little to do with Zeiss and nothing to do with any industry standard.

The phrase has spread from the online help pages of *f/Calc*, an interactive DOF calculator that was written in 1998 by Warren Young. The original help pages said, “*f/Calc* uses the commonly-accepted CoC value of 0.033mm for 35mm film, but some companies like Zeiss use a more demanding value of 0.025mm when making the depth of field marks on their lens barrels. That number is calculated as 1/1730 of the diagonal of the frame. You can use the same formula for other film formats.” By March 2001, before *f/Calc* was moved to its new site, its new *CoC.htm* page says “*f/Calc* calculates the CoC using the ‘Zeiss formula’: $d/1730$, where d is the diagonal measure of the film, in millimeters. This formula yields acceptable values for most uses.” It appears that he thereby just coined the term “Zeiss formula” and the superfluous “in millimeters” phrase that everyone else copied.

But where did Warren Young get the idea that Zeiss uses 0.025 mm or 1/1730 of the format diagonal? From David M. Jacobson’s popular online *Photographic Lenses FAQ* and *Photographic Lenses Tutorial*. The FAQ of December 1996 says:

“Q8. What is meant by circle of confusion?

“A. When a lens is defocused, a object point gets rendered as a small circle, called the circle of confusion. (Ignoring diffraction.) If the circle of confusion is small enough, the image will look sharp. There is no one circle ‘small enough’ for all circumstances, but rather it depends on how much the image will be enlarged, the quality of the rest of the system, and even the subject. Nevertheless, for 35mm work $c=.03$ mm is generally agreed on as the diameter of the acceptable circle of confusion. Another rule of thumb is $c=1/1730$ of the diagonal of the frame, which comes to .025mm for 35mm film. (Zeiss and Sinar are known to be consistent with this rule.)”

The December 1995 Tutorial gives a little background on how Jacobson came up with those numbers:

“Although there is no one diameter that marks the boundary between fuzzy and clear, .03 mm is generally used in 35mm work as the diameter of the acceptable circle of confusion. (I arrived at this by

observing the depth of field scales or charts on/with a number of lenses from Nikon, Pentax, Sigma, and Zeiss. All but the Zeiss lens came out around .03mm. The Zeiss lens appeared to be based on .025 mm.)”

In a personal communication, Jacobson confirms that this estimate was based on his “Rollei B-35 with 40mm f/3.5 Carl Zeiss Triotar lens,” and that he got a similar value from measurements of a friend’s Sinar camera, and that these led to his 1/1730 estimate and his comments in the FAQ.

In 1997, Carl Zeiss began publication of their “Camera Lens News” quarterly newsletter; the first issue had this to say about the COC limit used in depth of field scales:

“A certain amount of blur is supposed to be tolerable. According to international standards the degree of blur tolerable is defined as 1/1000th of the camera format diagonal, as the normally satisfactory value. With 35 mm format and its 43 mm diagonal only 1/1500th is deemed tolerable, resulting in $43 \text{ mm}/1500 \gg 0.030 \text{ mm} = 30 \text{ }\mu\text{m}$ of blur.”

This article explains that “ ‘Depth of field is insufficient’ is the most common complaint to meet the Carl Zeiss service department today,” due to the improvements in lens sharpness and film sharpness since the standards were set. It is perhaps possible that they had earlier reacted to this increase in service calls by tightening up their COC limit for computing lens DOF markings from about 30 μm to about 25 μm , but I don’t think they did so explicitly, nor did they ever state the divisor 1730. David Jacobson reverse engineered what Zeiss had done on one or two cameras, approximately, and put a number to it; later, Warren Young put a name to it, and the “Zeiss formula” caught on rapidly from there, among web amateurs. I have not found anything like it in any serious photographic publications. It is a perfectly reasonable formula, but does not have the historical basis that its name seems to claim.

For the sake of completeness, I duplicated Jacobson’s calculations from many Zeiss lens images that I was able to find, including a photo of his Triotar lens that Jacobson made me for this purpose. See Figures 5, 6, and 7. The 40mm Triotar is the only one consistent with the 1/1730 formula.



Figure 5. A Zeiss Ikon 28mm lens with depth-of-field scale. The hyperfocal distance appears to be about 1100mm at $f/22$, on 35mm format, which implies a relative COC criterion of $c = (28/43.3)(28/22)/1100 = 1/1350$. Other Zeiss lens images that I have examined, including medium format lenses, imply c values between 1/1533 and 1/1040, with one exception.



Figure 6. The actual Carl Zeiss Triotar 40mm $f/3.5$ lens from which David Jacobson measured $C = 0.025$ mm or $c = 1/1730$ (photo by David Jacobson). Interpreting the right-most dot as the $f/16$ far point at infinity, and the hyperfocal distance as about 13 feet or 4000 mm, we can confirm his numbers: $C = (40/16)(40/4000) = 0.025$; $c = (40/43.3)(40/16)/4000 = 1/1730$. The most notable property of this lens is its low cost due to its simple three-element construction; why the COC is so tight is a bit of a mystery.

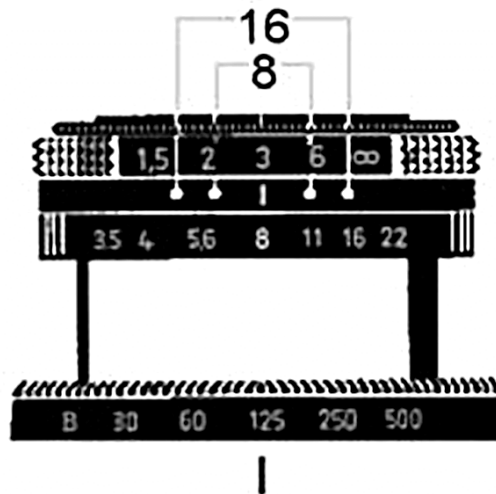

Figure 7. The drawing from the Rollei B35 user manual that shows the meaning of the DOF-scale dots of the Zeiss 40mm Triotar lens shown in Figure 6. This lens is marked in meters, while the one in Figure 6 is marked in feet. The drawing agrees with $f/16$ hyperfocal distance of 4 m that we had from the photo in Figure 6, but the example that accompanies the drawing is not consistent with these inferences: “Example: With the lens set to 10 feet and the aperture $f/8$, the depth of field extends from 6.5 feet to 20 feet.” These numbers are not consistent with the photo in Figure 6, but are approximately consistent with $C = 0.033$ mm, $c = 1/1300$, in agreement with Sidney Ray’s 1979 observation about Zeiss lenses.

Norman Koren’s page on DOF says he measured his Canon 50 mm lens and found “ $C = 50^2 / (16 * (5000 - 100)) = 0.032$ mm. I have found this to be typical of a large sample of Canon FD and older Leica M-series lenses,” which, for the 35 mm format and these brands at least, implies $c = 0.032 / 43.3 = 1/1350$. Kingslake agrees, in the *Leica Manual*, “Over the years it has become customary to simplify the problem by adopting a standard value for c' , the acceptable circle of confusion on the film. Many tests have shown that a reasonable value for c' is 1/30mm or 1/750 inch. That value has been adopted in all Leica depth-of-field tables and is used for the depth-of-field scales engraved on the lens barrels.”

The Method of von Rohr

I've found an elegant “outside the box” method of analysis in Moritz von Rohr’s 1906 (and 1911) books, similar to one in the 1920 translation of his 1904 book. Since T. R. Dallmeyer referred to “von Rohr’s interpretation” in 1899, it could be a quite early method of DOF analysis. See Figure 7, from von Rohr 1906; his 1899 book has a more conventional picture, with both pupils, and with inside and outside rays, and no equations.

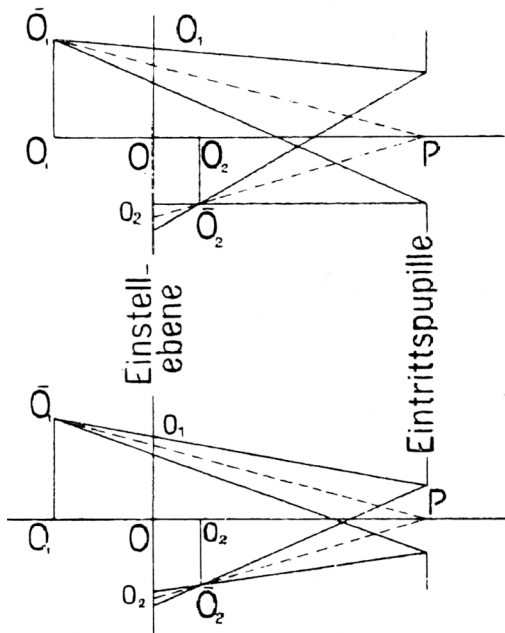

Fig. 20.
Zur Tiefe bei photographischen Objektiven.
 Der obere und der untere Teil der Figur stimmen in der Lage der Einstellebene, Eintrittspupille und der Objekte genau überein. Verschieden ist nur der Durchmesser der Eintrittspupille, der oben die doppelte Größe des unteren hat. Aus diesem Grunde sind die Zerstreungskreise $o_1 o_2$ in der Einstellebene O oben auch doppelt so groß wie unten, und das objektseitige Abbild $o_1 o_2$ ist oben doppelt so unscharf wie unten. (Aus Versehen steht oben in der Einstellungs-ebene O statt o_1 fälschlich O_1 .)

Figure 7. This drawing from von Rohr 1906 shows the same situation for two different diameters of the entrance pupil (Eintrittspupille). The object at O is in focus; a far object O_1 and a near object O_2 are displaced sideways to the locations with the over-bar notations for clarity. Each of these object points projects the entrance pupil directly to a circle of confusion in the field plane (Einstellebene). Translation provided by Dominic Groß: “Concerning depth [of field] with photographic lenses. The upper and lower parts of the figure are identical in the position of the field plane, entrance pupil and the object. The only difference is the diameter of the entrance pupil, the upper being twice the size of the lower. For this reason the upper circles of confusion $o_1 o_2$ are also twice the size of the lower ones at the field plane O and the object side image $o_1 o_2$ is twice as blurry as the lower. (By accident the print in the upper field plane O says O_1 instead of o_1 .)”

I quote from the 1920 English translation: “... we can calculate the distances ... in front of and ... behind the field-plane ... which the object-points may attain without exceeding the radius of indistinctness conforming to the angular sharpness of vision ...” and “At this point it will be sufficient to note that all these formulae involve quantities relating exclusively to the entrance-pupil and its position with respect to the object-point, whereas the focal length of the transforming system does not enter into them.”

By the way, such optical system diagrams are typically drawn with rays propagating from left to right, as von Rohr did, and unlike my figures. And when von Rohr says “in front of” he means to the left, as the far object point at O_1 , and “behind” means toward the right, as the near object point at O_2 , because

these directions refer to the direction of the propagating light (“*vor und hinter immer in Sinne der Lichtbewegung genommen*”). In photography, “in front of” and “behind” are more often interpreted the other way around, as referred to the subject facing the camera. Norman Koren’s pages use “front” and “rear;” similarly the terms “front focus” and “rear focus” are often heard from Canon DSLR users. I’ve used “near” and “far” to avoid this ambiguity in which way is front, more like Czapski’s and Dippel’s near and far points, “*Nahpunkte und Fernpunkte.*”

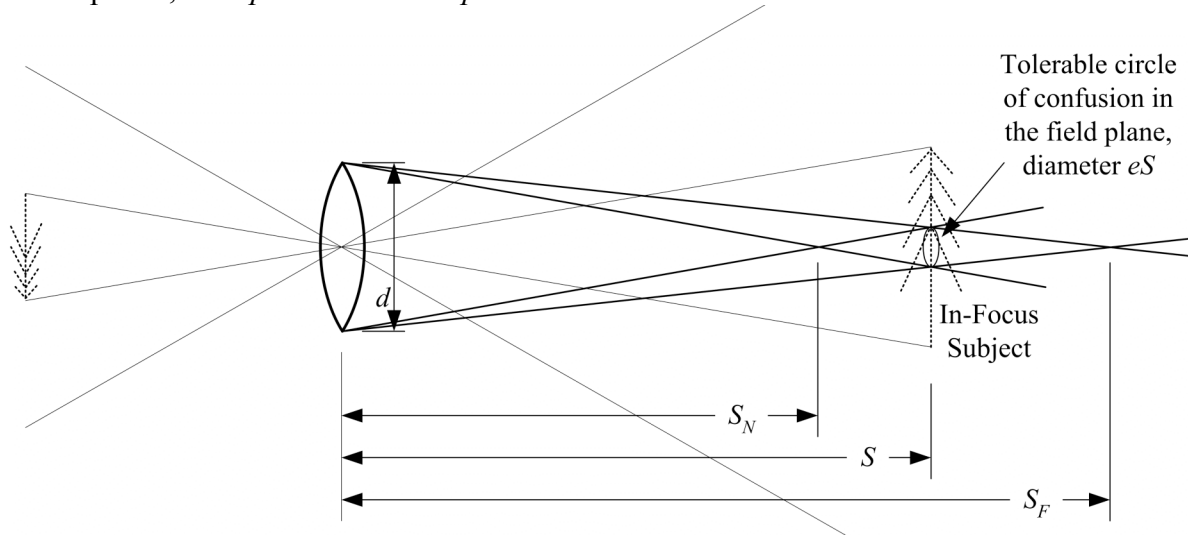

Figure 8. M. von Rohr’s interpretation, redrawn. The maximum acceptable blur circle diameter in the field plane is eS , in my formulation, as determined by the maximum acceptable angular confusion e . Rays through the nearest and farthest acceptable subject points project to a virtual image with that much blur in the field plane, which is then imaged onto the focal plane.

I’ve redrawn von Rohr’s interpretation my way in Figure 8. Using similar triangles with bases at the lens aperture and at the circle of confusion in the field plane, the solutions come out the same as before:

$$S_N = Sd/(d + eS) = Sd/(d + C_S)$$

$$S_F = Sd/(d - eS) = Sd/(d - C_S)$$

The hyperfocal distance corresponds to the triangle bases being equal: $d = eS$. The rays to the far point at infinity are parallel in that case.

Rudolf Kingslake, Kodak’s director of optical design, was a follower of von Rohr’s approach. He observed in *A History of the Photographic Lens*: “It can be readily shown that the depth of field in a photograph depends mainly on the distance of the subject and the linear diameter of the lens aperture, while the exposure time depends only on the F-number.”

A diagram very similar to Figure 8 (except for my backwards direction) is provided by Kingslake in 1973 in his “Camera Optics” chapter of the 15th edition *Leica Manual*. Instead of the near and far distances S_N and S_F , he provides simple formulae for the depth differences $S - S_N$ and $S_F - S$ in terms of the subject-space COC ($C_S = eS$) and the subject distance S :

$$S - S_N = SC_S/(d + C_S)$$

$$S_F - S = SC_S/(d - C_S)$$

These differences have formulae similar to the distances S_N and S_F above, except for a factor in the numerator changed from d to C_S . The similar triangles with bases at the entrance pupil and at the

subject-plane COC should make this relationship obvious. If we substitute eS for C_S , Kingslake's formulae look more complicated, with the square of S in the numerator. Re-writing in terms of d/S (an angle, approximately, or $2\tan u$) would make it simpler; here's how it comes out:

$$S - S_N = eS^2/(d + C_S) = eS/(d/S + e)$$

$$S_F - S = eS^2/(d - C_S) = eS/(d/S - e)$$

$$S_N = d/(d/S + e)$$

$$S_F = d/(d/S - e)$$

The formulae with $e = cw$ make good sense for general photography; using an absolute blur limit at the subject, C_S , makes more sense for macro and micro photography.

The Roots of DOF Formulae are Outside the Box

Since von Rohr was an editor of a rewrite of Czapski's 1893 book, I tracked that one down and found depth of field equations there, too. Czapski relates the diameter of the scatter circle or *Zerstreuungskreis* in the *Bildebene* (picture plane) to focus distance, object distance, magnification, and the angle subtended by the entrance pupil radius from the focus distance. With appropriate translations, the relations agree with the modern ones, but they were not solved for near and far distances; the scatter circle diameter is a dependent variable, like this:

$$C = m(S_F - S)(S/S_F)(d/S)$$

$$C = m(S - S_N)(S/S_N)(d/S)$$

Where he represents d/S as $2 \tan u$, u being the angle from optic axis to outer edge of entrance pupil as seen from the subject; it's that pesky twice the tangent of a half angle again, which is exactly d/S in this case. He goes on to point out that Abbe used a sine, instead of tangent here, but that the difference is often negligible.

Czapski then makes the approximation that S/S_F and S/S_N are close enough to one and solves for the total DOF.

$$S_F - S_N = 2(C/m)(S/d)$$

where the S/d is from his $2 \tan u$ again in the denominator. He went through some other machinations in between, using a modified magnification, but let's skip all that. In this formulation, C and m are "dark side" parameters, but their ratio, the blur diameter at the subject, our eS , is not, so it's easy to see how Czapski's formula is equal to our total DOF approximation $2S^2/S_H$.

Czapski credits Abbe 1880, in the context of microscopy where m is much greater than 1, but I haven't found that article yet. He says visual acuity is about 1 to 5 minutes of arc, depending on intensity of the picture, color, excitation condition, etc.

After studying Czapski, I discovered Google Book Search (books.google.com) and found another German book on microscopy by Dippel from 1882 with similar formulae using the magnification and the tangent:

$$2\delta/D = n\omega/(2a \tan u)$$

where u is the half-angle of the edge of the entrance pupil as seen from the subject (he called it w , but I modernize it to u to be consistent with everyone else), ω is the human observer's angular visual resolution, n is the index of refraction of the medium between the subject and the objective lens, a is the magnification, δ is the one-sided DOF, and D is the normal viewing distance of a human observer. This formula is consistent with our macro approximation, or Czapski's, and is essentially "outside the box" in that it relies on an angular criterion in object space and an entrance pupil size. For our purposes, in air, the index n can be ignored (it's not clear to me why it is there at all), and the way to think of the D and a factors is that the subject at distance S is enlarged by a factor a and viewed at distance D with an angular criterion ω , so the angular criterion e in subject space is given by

$$e = \omega D/(aS) \text{ or } eS = \omega D/a$$

Using $2a \tan u = d/S$, the macro one-sided DOF is thus in agreement with our previous result $S(eS/d)$:

$$\delta = D \omega/(2a \tan u) = eS(S/d)$$

Dippel refers to indistinctness circles (*Undeutlichkeitskreise*) as opposed to Czapski's scatter circle (*Zerstreuungskreis*).

Many microscopy texts have formulas for DOF (called Focustiefe, Sehtiefe, Penetration, focus depth, penetration depth, and such) in terms of the numerical aperture, $NA = n \sin u$, but none that I can find provide a derivation. The NA was defined by Abbe to describe the diffraction-limited resolution of a microscope. The use of the index n and the sine function are both appropriate to this use. I believe many authors subsequently used NA where they should have just used $\tan u$ in a DOF formula, the difference being usually not too great, but up to about a factor of two for very-high-NA microscope objectives.

That the credit for DOF, at least in microscopy, should go to Abbe is supported by a statement of Frederick W. Mills in 1891: "Penetration (known by photographers as 'depth of focus') has been in the past a much-discussed question. Professor Abbé was the first to solve this mystery."

Roots of the Conventional Approach

While Abbe was advancing optical theory in Germany in the 1870s, Dallmeyer and others in England were practicing the art of photographic optics and figuring out their own approach to DOF. I don't find formulas that early, but the opening quote by J. H. Dallmeyer 1874 expresses the key relationships:

"Depth of focus, or depth of definition, is dependent upon the aperture and the focal length of a lens. It increases in the same ratio as the diameter of the aperture is reduced, and it diminishes as the square for any increase in the size of picture, or the focal length of lens."

This squared focal-length dependence would not have been correct or sensible with respect to the custom of that time of specifying apertures by their diameters. But Dallmeyer was a proponent of the use of the "intensity ratio" or "aperture ratio" to describe stops, and his inverse square derives from his assumption that the stop increases its diameter in proportion with the focal length, just as in present-day formulae involving the f-number and focal length. He used a circle of confusion criterion based

explicitly on visual acuity, and it seems clear that he was not talking about changing his format size or sharpness criterion while changing focal length.

When his son Thomas R. Dallmeyer refers to “the well-known formulae for front and back ‘depth of field’,” in 1899, he may have been referring to his father’s work or someone else’s. I haven’t yet found any actual early formulas in English publications.

It would be interesting to know if anyone used formulae with a first-order focal length dependence and an absolute aperture diameter, instead of aperture ratio and the square. In fact, I did find such an algorithm in words, by E. J. Wall in his 1889 *A Dictionary of Photography*:

“Having focussed any point, to find the distance in front of that point which will be in focus (all measurements to be in inches, and the distance of object to be measured from the optical center of the lens)—

1. Multiply the focal length by the diameter of the stop, and the result by the difference between the focal length and the distance of the subject.
2. Multiply the focal length by the diameter of the stop, and add 1/100 part of the distance of the object.
3. Divide the first product by the last, add the focal length, and subtract the result from the distance of the object, when the result will be the distance sought for in front in inches.

To find the depth of focus behind a given point—

1. Multiply the focal length by the diameter of the stop, and the result by the difference between the focal length and the distance of the subject.
2. Multiply the focal length by the diameter of the stop, and subtract 1/100 part of the distance of the object.
3. Divide the first product by the last, add the focal length, and subtract the result from the distance of the object; the result is the distance behind in inches.”

Which I translate to formulae this way:

$$S - S_N = S - (fd(S - f)/(fd + S/100) + f)$$

$$S_F - S = (fd(S - f)/(fd - S/100) + f) - S$$

It is obvious that dimensionally the 1/100 must be a distance in inches; let’s call it C , since 1/100 inch is a typical COC for a large-format camera of that era. Simplifying to just the near and far limits:

$$S_N = fd(S - f)/(fd + SC) + f = S(fd + fC)/(fd + SC)$$

$$S_F = fd(S - f)/(fd - SC) + f = S(fd - fC)/(fd - SC)$$

which, by moving fC from numerator to denominator with opposite sign, are seen to be extremely close to the conventional near and far formulae using f-number $N = f/d$ and the square of f :

$$S_N = Sfd/(fd + SC - fC) = Sf^2/(f^2 + NC(S - f))$$

$$S_F = Sfd/(fd - SC + fC) = Sf^2/(f^2 - NC(S - f))$$

I wish I could figure out how Wall came up with this algorithm that seems to be very close, but not exact, compared to modern derivations. Could these be the “well known formulae” that Dallmeyer refers to?

An early precursor to DOF calculations is the 1866 calculation of a COC diameter from a subject distance, for a lens focused at infinity, in a one-page article “Long and Short Focus” by an anonymous T. H. The formula he comes up with is equivalent to $C = fd/S$. But he does not invert this to find the S corresponding to a given C criterion, nor does he consider focusing at any other distance than infinity. But he observes “long-focus lenses have usually a larger aperture than short ones, and *on this account* have less depth of focus” [his italic emphasis]. This is an early outside-the-box interpretation.

Rambling Historical Notes

After working on format-dependence of DOF algebraically, the hard way, for a while, and discovering the independence from format when the absolute lens opening is considered, and before discovering von Rohr, I discovered a similar observation in a 1939 paper in the RCA *Television* collection. Iams et al., in comparing TV pickup tubes of different sizes and sensitivities, note that “only the diameter of the lens determines the distance which an object can be moved toward or away from the lens without the image being blurred a given percentage of its height.” This statement is sensible only with the interpretation that the object is filling the frame, or at least kept at a constant fraction of the frame size, as one compares different formats and focal lengths; that is, they ignore field-of-view dependence by assuming constant field of view. They use the term “circle of diffusion” with diameter δ (delta); dividing by the magnification m (from object to image), they get the object-space blur size $\delta/m = D\Delta x/x$ for absolute aperture diameter D , object distance x , and displacement from focus Δx , “indicating that the depth of focus at the object is dependent only upon the lens diameter.” This δ/m is Merklinger’s “disk of confusion” below.

After I developed this approach, I discovered that Merklinger had done about the same thing and published a book on it in 1990: *The Ins and Outs of Focus: An Alternative Way to Estimate Depth-of-Field and Sharpness in the Photographic Image*. But Merklinger has some unusual twists that I can’t quite agree with.

Both Iams et al. and Merklinger focus on the absolute blur on an object, giving no allowance for the magnification of the disk of confusion changing with distance as an object is moved forward or back, so that the distances in front of and behind the ideal focus distance are equal, in their view. With this symmetry there is no such thing as a hyperfocal distance, since objects at infinity have an infinite disk of confusion when the focus distance is finite. This symmetric approach is sometimes a useful simplification, but is not very descriptive of the actual perceived depth-of-field situation when DOF is large.

Following up clues from T. R. Dallmeyer, I later found that Moritz von Rohr had published an outside-the-box DOF analysis in 1904, essentially projecting points from objects at all depths onto the “field plane” at the subject distance to get a circle of indistinctness in that space, as mentioned above. More about that below.

James Mitchell, editor of the second through fourth editions of *The Ilford Manual of Photography*, also noticed an external aperture relationship: “Assuming the permissible circle of confusion to have a diameter equal to $f/1000$ then [the hyperfocal distance] is equal to $1000 \times$ effective diameter of the lens.” His assumption corresponds to our model in the case of a fixed angle of view, i.e. if format size is proportional to focal length.

J. H. Dallmeyer 1874 has an interesting bit about the angular field of view of a camera, indicating how

difficult it might be for a typical photographer to understand and apply a simple trigonometric formula:

“To find the *angle of view*, or the amount of subject included in a picture, ascertain the equivalent focus of the lens, and measure the base line of the picture. Upon a sheet of paper draw a line of the same length as the latter, bisect it, and let fall a perpendicular exactly equal in length to the equivalent focus of the lens; join the extremity of bisected line and perpendicular by another line; now apply a protractor, and measure the angle included between these two lines, and the angle read off, multiplied by two is the angle included in the picture. Or, with the data known as above, and a table of natural sines and tangents at hand, divide half the base line of the picture by the equivalent focus of the lens; find in the tables under the heading ‘tangents’ the same number as the above quotient, and the corresponding angle, multiplied by two, is the angle included in the picture.

“The following particulars may be of service:—

“If the base line, or the longest side of the picture, is equal to the equivalent focus of the lens, the angle included is 53 degrees...” [about a radian, which is 57.3 degrees].

We prefer to ignore this trigonometric complexity, as photographers don’t usually care to measure their equipment or scenes with rulers and protractors. The ratio $w = W/f'$ is not exactly an angle, but its small fraction $e = wc$ is almost exactly the angle that in the center of the field corresponds to the COC diameter limit Wc . So there is really no advantage to deal with the angle $2\arctan(w/2)$ if one is willing to stick to ratios and natural units such as radians.

Merklinger has a small historical note that skips from finding no formulae for DOF in Bothamley’s *Ilford Manual of Photography* (c.1906) to a fully developed traditional approach in the *Leica Handbook* by Vith, 1933. I have been able to find a few more historical precedents, starting in the nineteenth century.

Désiré van Monckhoven calls it “depth of focus” in his 1867 *Photographic Optics*, but mixes subject-space and focal-plane ideas in his informal definition:

“Depth of focus is the property of lenses of giving a clear image in planes of which the distance is unequal. It follows from this that the ground-glass placed at the focus of a lens may be moved to a very slight extent without the image sensibly losing its sharpness.”

Monckhoven does not have formulae, but has a qualitative description of why DOF is larger for distant subjects, based on a table of lens extensions needed for different subject distances:

“Thus, then, the depth of focus of the lens varies with its aperture, and the distance of the objects which form the image at its focus. It also varies according to the form of the lens or the optical combination of lenses composing an objective.”

This latter observation is somewhat confused with different focal lengths and different degrees of spherical aberration, and is no longer generally relevant or correct.

Taylor (1892) calls it “depth of focus, or, more correctly, of definition.” Sir Abney calls it “depth of focus” in multiple editions (1888-1905) of his *Treatise on Photography*:

Abney’s formulae assume that the exposed plate is the image being viewed; that is, there is no enlargement (magnification from negative to print) nor format size in his calculations. He includes a table of DOF for focal length from 10 to 50 cm and “Intensity, or Aperture Ratio” from 1/10 to 1/40.

This was before “*f* stops,” I presume. Abney says “Mr. Dallmeyer insists that the aperture of a diaphragm should always be expressed in terms of the focal length. Thus an aperture of 5 centimetres when used with a lens of 50 centimetre focus, should be called 1/10 aperture, which is a means of expressing the intensity of a lens.”

Since Abney cites 1876 and 1877 articles, I presume that the Mr. Dallmeyer he refers to is the elder, John Henry, who pushed this concept first, for example in his 1874 lens brochure:

“The *rapidity* of a lens depends upon the relation, or the ratio, of aperture to the equivalent focus. To ascertain this, divide the *equivalent focus* by the diameter of the actual *working aperture* of the lens in question; and note down the quotient as the denominator of a fraction with 1, or unity, for the numerator. Thus to find the ratio of a lens of 2 inches diameter and 6 inches focus, divide the focus by the aperture, or 6 divided by two equals 3; *i.e.*, 1/3 is the intensity ratio. ... and this ratio once ascertained, it only remains to multiply each denominator by itself to find their comparative rapidities.

... “It would be of great advantage to photographers generally, if, in the description of experiments, &c., the above *intensity ratio* were always recorded, as it is the only real standard of comparison between the rapidities of different lenses.”

After his DOF table, Abney gives a formula for the nearest distance that will be sharp when the focus is at infinity: $p = 0.41f^2a$, where f is the focal length, a is the aperture ratio (reciprocal of f -number), and the answer is in meters (he must implicitly mean that the f is in cm to be consistent with his 0.025 cm COC diameter, the answer in meters, and the dimensionally sensible formula $p = f^2a/C$; and his 0.41 should obviously be 0.40).

This concept is exactly what Ray (in Jacobson 1978) defines as the hyperfocal distance—in his terms, $h = f^2/(cN)$; the previous editors of that manual had done the same. Since focusing at this distance would make the image just about sharp enough at infinity, it is almost the same as the usual definition; but it’s not quite identical, differing by just one focal length in the usual formation, which amounts to a correction for lens extension. It must be noted, however, that in the transition from the seventh edition to the eighth edition of the *Manual of Photography*, Ray changed from that definition to the more modern one, saying “the *hyperfocal distance* h is defined as the value of a particular focus setting u of the lens, which makes [the far limit] equal to infinity.” He still gets the same answer as before, however, because he has already assumed that the distance to the “conjugate image plane” is about equal to the focal length.

By the way, in his 1979 book *The Photographic Lens*, Ray uses both versions, and makes an interesting observation that simplifies DOF calculations to a simple discrete set of easy-to-remember overlapping focus ranges:

“When a lens is focused on infinity, the value of D_n is the ‘hyperfocal distance’ H . When the lens is focused on distance H , the depth of field extends from infinity to $H/2$.; and when focused on $H/3$ extends from $H/2$ to $H/4$ and so on. This concept simplifies the depth of field equations considerably.”

I subsequently found this same observation in Mortimer (1938), Sinclair (1913), and Piper (1901). Sinclair credits Piper with the idea; Piper calls it “consecutive depths of field” and shows how to easily test the idea.

The Manual of Photography, formerly *The Ilford Manual of Photography*, is a great resource for

tracking changes in the field of photography, such as Ray's changed definition of hyperfocal distance. Alan Horder edited the fifth and sixth editions, and presided over the name change from the one to the next, with the publisher change from Ilford Ltd. to The Focal Press in 1971.

But let's get back to the nineteenth century. Based on his formulae, and on the notion that the "aperture ratio" should be kept fixed in comparisons across formats, Abney says, "It can be shown that an enlargement from a small negative is better than a picture of the same size taken direct as regards sharpness of detail." He realized, however, that that was not the whole story: "Care must be taken to distinguish between the advantages to be gained in enlargement by the use of a smaller lens, with the disadvantages that ensue from the deterioration in the relative values of light and shade."

Sutton and Dawson's, *A Dictionary of Photography*, 1867, had previously defined "focal range" similar to what Abney computed:

"Focal Range. In every lens there is, corresponding to a given apertal ratio (that is, the ratio of the diameter of the stop to the focal length), a certain distance of a near object from it, between which and infinity all objects are in equally good focus. For instance, in a single view lens of 6 inch focus, with a 1/4 in. stop (apertal ratio one-twenty-fourth), all objects situated at distances lying between 20 feet from the lens and an infinite distance from it (a fixed star, for instance) are in equally good focus. Twenty feet is therefore called the "focal range" of the lens when this stop is used. The focal range is consequently the distance of the nearest object, which will be in good focus when the ground glass is adjusted for an extremely distant object. In the same lens, the focal range will depend upon the size of the diaphragm used, while in different lenses having the same apertal ratio the focal ranges will be greater as the focal length of the lens is increased.

"The terms 'apertal ratio' and 'focal range' have not come into general use, but it is very desirable that they should, in order to prevent ambiguity and circumlocution when treating of the properties of photographic lenses. 'Focal range' is a good term, because it expresses the range within which it is necessary to adjust the focus of the lens to objects at different distances from it—in other words, the range within which focusing becomes necessary."

Their focal range is about 1000 times their aperture diameter, so it makes sense as a hyperfocal distance with c value of 1/1000, assuming the lens is a "normal" lens. What is not clear, however, is whether the focal range they cite was computed, or empirical.

Wilson's Photographics, 1883, says not much more than "If you use too large a diaphragm, or increase the length of focus in the camera, you lose a quality in your pictures known as *depth of focus*." and "By the use of diaphragms the definition of the picture is increased, and they increase the focal depth."

Wilson's Quarter Century in Photography, 1887, quotes J. H. Dallmeyer without a specific date reference: "As a rule, focus for some prominent object in the foreground, or upon that which is to constitute the point of interest in the picture. Do this with a medium stop, then insert the next, or the next but one smaller, sufficient to prevent objects not focussed upon appearing too much blurred."

Taylor 1892 recalls this word formula:

"We have seen it laid down as an approximative rule by some writers on optics (Thomas Sutton, if we remember aright), that if the diameter of the stop be a fortieth part of the focus of the lens, the depth of focus will range between infinity and a distance equal to four times as many feet as there are inches in the focus of the lens."

This could mean that half the hyperfocal distance is 40•48 times the aperture diameter, implying $e = 1/3840$; or $e = 1/1920$ if he meant focused at infinity.

John Hodges in 1895 discusses depth of field without formulas but with some of these relationships:

“There is a point, however, beyond which everything will be in pictorially good definition, but the longer the focus of the lens used, the further will the point beyond which everything is in sharp focus be removed from the camera. Mathematically speaking, the amount of depth possessed by a lens varies inversely as the square of its focus.”

This “mathematically” observed relationship implies that he had a formula at hand, and a parameterization with the f-number or “intensity ratio” in it. To get an inverse-square relation to focal length, you have to assume that the COC limit is fixed and the aperture diameter scales with the focal length, giving a constant f-number. Either letting the COC limit scale as the focal length or letting the aperture diameter be fixed would change the dependence to simply inverse with focal length, and making both changes would make the answer independent of focal length. Hodges was probably not the earliest to muddy these relationships by not stating his assumptions; J. H. Dallmeyer had said something similar in 1874.

The oldest DOF calculations other than focal range that I’ve found in English are in 1899 by Thomas R. Dallmeyer, the inventor of the telephoto lens and a promoter of the aperture ratio idea, along with his father. He refers to “the well-known formulae for front and back ‘depth of field,’” so it’s clear that I have more to find (I’ve since found some in German, by Czapski, 1893, and Dippel 1882, all deriving from Abbe). He describes a slightly different “outside the box” approach under the section title “*Depth of Focus* (Von Rohr’s interpretation),” based entirely on the entrance pupil and magnification. Dallmeyer makes a big deal about the difference between the depth of field of a telephoto lens and an ordinary lens of the same focal length, but then shows that the difference only depends on the entrance pupil being a little further from the subject, and is negligible at a great distance. His treatment of an acceptable “circle of indistinctness” is quite confusing, being tied up with internal details of telephoto lens construction. He has complete formulae for front and back depth of focus or depth of field, but in terms that are tricky to interpret.

Thomas Dallmeyer’s father, John Henry Dallmeyer, in his 1874 pamphlet on photographic lenses, has a description of DOF that practically puts a formula into words and previews the concept of hyperfocal distance:

“Depth of focus, or depth of definition, is dependent upon the aperture and the focal length of a lens. It increases in the same ratio as the diameter of the aperture is reduced, and it diminishes as the square for any increase in the size of picture, or the focal length of lens. Hence, the shorter the focal length, other things being equal, the greater the ‘depth,’ or the nearer may be an object in the foreground, beyond which everything else will be in practically good focus.”

His son’s 1892 expanded version of the pamphlet, quoting the original British edition that I have not seen, includes more about these concepts, such as

“Thus every point in an object out of focus is represented in the picture by a disc, or circle of confusion, the size of which is proportionate to the aperture in relation to the focus of the lens employed. If a point in the object is 1/100 of an inch out of focus, it will be represented by a circle of confusion

measuring but 1/100 part of the aperture of the lens.”

This latter statement is clearly incorrect, or misstated, being off by a factor of focal distance. He goes on,

“and when the circles of confusion are sufficiently small the eye fails to see them as such; they are then seen as points only, and the picture appears sharp. At the ordinary distance of vision, of from twelve to fifteen inches, circles of confusion are seen as points, if the angle subtended by them does not exceed one minute of arc, or roughly, if they do not exceed the 1/100 of an inch in diameter.”

A simple calculation verifies that one minute of arc at fifteen inches is closer to 1/200 of an inch. This is the same factor-of-two error that Abney made in metric units. Perhaps Abney got it from J. H. Dallmeyer and just converted the numbers (1/100 inch became 0.025 cm, 15 inches became 40 to 50 cm). Beck and Andrews (circa 1902) got closer when they said, “It has been assumed that a point will appear as a point in the photograph so long as it is not a circle of more than 1-100 inch in diameter when viewed at a convenient distance of 12 inches, in other words, as long as it does not subtend an angle of more than three minutes to the eye.” A hundredth of an inch at 12 inches is 1/1200 radian or 0.833 milliradians, compared to three minutes which is $1000 \cdot 3/60 \cdot \pi/180 = 0.872$ milliradians; close enough. Horder 1958 takes 1/100 inch in 10 inches (1 in 1000, 1 milliradian) to be 3 minutes of arc (0.872 milliradians); not as close, but not too bad; and adds, “For work that will stand the closest scrutiny, however, the more stringent standard of 1 in 2500 must be used.”

T. R. Dallmeyer 1899 defines the “intensity” of a lens to be its aperture diameter divided by focal length, and uses the notation $f/8$ for the aperture of a lens of intensity 1/8. This use of *intensity* is not consistent with any other engineering use of the term, so it didn’t catch on; behind a lens, the light intensity is proportional the square of Dallmeyer’s “intensity.” His father J. H. Dallmeyer in 1874 referred to a lens’s “intensity ratio” as an important property of the lens, but didn’t really call that ratio an intensity per se. He also used “rapidity” and “rapidity of action,” and showed how to calculate relative rapidities, or relative exposure times, by squaring the intensity ratios. The term “rapidity” must have led to today’s common term “speed,” such as used in quotation marks by Allen Greenleaf in 1950. Abney used “speed” and “rapidity” to describe shutters in his tenth edition, but he didn’t use these terms for lenses.

Beck and Andrews 1902 discuss “Depth of Focus or Definition” for what we now call “Depth of Field,” and show a “Table of Depth of Focus,” or “the distance beyond which all objects will be sharp.” They list lens “rapidity” or “ratios marked on stops” from $f/7, f/8, f/9, f/10$, etc. to $f/20$. They don’t say for sure, but their numbers are consistent with being hyperfocal distance for $C = 1/100$ inch, or with being half of hyperfocal distance for $C = 1/200$ inch. They used both values in preceding pages, saying

“A circle of 1-100 inch diameter, it will be remembered, was taken as the maximum allowable for good definition when the print was viewed at a distance of 12 inches, but with this limit of sharpness the photographer must be content that his picture, which is perhaps a ¼-plate print made from a 6-inch lens, shall remain a ¼-plate, as any enlargement will so increase the circles of confusion that the picture will become definitely blurred. When photographs are to be enlarged or critically viewed for their definition, points should not be represented by circles of more than 1-200 inch in diameter; this is the limit that Messrs. R. & J. Beck take as their standard in the ‘Frena’ hand cameras, and the distances within which objects are sharply defined are calculated on this basis.”

Beck and Andrews also mention that “ $f/4$... it is only in special cases that a lens having a larger aperture than this will come into the hands of a photographer.” Abney, in his 1905 tenth edition, mentions that

with the introduction of Jena glass, some lenses of good definition can be made “with apertures as large as $f/5.6$.” This f -number notation that Dallmeyer promoted as a way to write the aperture diameter seems to be coming into wide use by then.

Speaking of aperture conventions, the 1891 *Ilford Manual of Photography* by C. H. Bothamley discusses the relation between the “Uniform System” of U.S. stops adopted by the Photographic Society of Great Britain (now the Royal Photographic Society) and the “Intensity Ratio” system of Dallmeyer. Both systems seem to be very inappropriately named there. The U.S. system did catch on in the U. S. for a while when Eastman Kodak used it on their cameras from at least 1910 to 1922; the numbers are inversely proportional to intensity, but that term was applied to the other system. Bothamley in 1891 said “The stops of all the best makers are now arranged according to this system,” yet U. S. stops did not last in the face of the much more explainable f -number system. By 1895, Hodges contradicts Bothamley, saying, “This is called the f/x system, and the diaphragms of all modern lenses of good construction are so marked.” He relates the f/x system to the U. S. system using the sequence $f/4, f/5$ [sic], $f/8, f/11.3$, etc. Beck and Andrews talk about the R.P.S standard of $f/4, f/5.6, f/8, f/11.3$, etc. Apparently the R.P.S. had moved off of the U. S. system some time between 1895 and 1902.

Piper in 1901 discusses five different systems of aperture marking: the old and new Zeiss systems based on actual intensity (proportional to reciprocal square of the f -number); and the U. S., C. I., and Dallmeyer systems based on exposure (proportional to square of the f -number). He calls the f -number the “ratio number,” “aperture ratio number,” and “ratio aperture.” He calls expressions like $f/8$ the “fractional diameter” of the aperture, even though it is literally equal to the “absolute diameter” which he distinguishes as a different term. He also sometimes uses expressions like “an aperture of $f8$ ” without the division indicated by the slash.

Beck and Andrews have a similar comparison, with six columns representing a somewhat different assortment of aperture systems, the first being “ $f/$ RPS System—Beck and Beck-Steinheil lenses” with entries starting from $f/4$ and in a strange irregular progression. The other five columns hold pure integer numbers only, with column heads “U. S. System—Beck and other English makers,” “Zeiss System—Zeiss new lenses,” “Goerz System—All Goerz lenses,” “Voigtlander—Collinear,” and “Dallmeyer System—Dallmeyer old lenses.”

Piper may be the first to have published a clear distinction between “Depth of Field” in the modern sense and “Depth of Definition” in the focal plane, and implies that “Depth of Focus” and “Depth of Distance” are sometimes used for the former. He uses the term “Depth Constant” for H , and measures it from the front principal focus (i. e., he counts one focal length less than the distance from the lens to get the simpler formula), and even introduces the modern term, “This is the maximum depth of field possible, and $H + f$ may be styled the distance of maximum depth of field. If we measure this distance extra-focally it is equal to H , and is sometimes called the hyperfocal distance. The depth constant and the hyperfocal distance are quite distinct, though of the same value.” I’m not sure I appreciate the distinction. By Table I in his appendix, he further notes, “If we focus on infinity, the constant is the focal distance of the nearest object in focus. If we focus on an extra-focal distance equal to the constant, we obtain a maximum depth of field from approximately half the constant distance up to infinity. The constant is then the hyper-focal distance.”

I have not found the term *hyperfocal* before Piper, nor *hyper-focal* which he also used, but he obviously did not claim to coin this descriptor himself.

By 1909, in Johnson’s *Photographic Optics and Colour Photography*, the term “Depth of Field” is used

for what Abney called “Depth of Focus,” and “Depth of Focus” is used for the first time in the modern sense, as the allowable distance error in the focal plane. I quote his definitions:

“Depth of Focus is a convenient, but not strictly accurate term, used to describe the amount of racking movement (forwards or backwards) which can be given to the screen without the image becoming sensibly blurred, *i.e.* without any blurring in the image exceeding 1/100 in., or in the case of negatives to be enlarged or scientific work, the 1/10 or 1/100 mm. Then the breadth of a point of light, which, of course, causes blurring on both sides, *i.e.* 1/50 in = $2e$ (or 1/100 in = e).”

His drawing makes it clear that his e is the radius of the circle of confusion. He has clearly anticipated the need to tie it to format size or enlargement, but has not given a general scheme for choosing it.

“Depth of Field is precisely the same as depth of focus, only in the former case the depth is measured by the movement of the plate, the object being fixed, while in the latter case the depth is measured by the distance through which the object can be moved without the circle of confusion exceeding $2e$.

“Thus if a lens which is focused for infinity still gives a sharp image for an object at 6 yards, its depth of field is from infinity to 6 yards, every object beyond 6 yards being in focus.

“This distance (6 yards) is termed the hyperfocal distance of the lens, and any allowable confusion disc depends on the focal length of the lens and on the stop used.

“If the limit of confusion of half the disc (*i.e.* e) be taken as 1/100 in., then the hyperfocal distance

$$H = Fd/e$$

d being the diameter of the stop, ...”

His use of *former* and *latter* seem to be swapped; perhaps *former* was here meant to refer to the immediately preceding section title Depth of Focus, and *latter* to the current section title Depth of Field. Except for an obvious factor-of-2 error in using the ratio of stop diameter to COC radius, this definition is the same as Abney’s hyperfocal distance. He also commits the sin of using the equal sign of the equation as the verb in his sentence, but we’ll forgive him.

The term *hyperfocal distance* also appears in Cassell’s *Cyclopaedia* of 1911, *The Sinclair Handbook of Photography* of 1913, and Bayley’s *The Complete Photographer* of 1914.

By 1932, DOF calculations are fully developed in Hardy and Perrin, *The Principles of Optics*. Their concepts, formulae, and terminology conform to modern usage, including the modern definition of hyperfocal distance: “If a camera is focused on an object plane at this distance from the first focal point, all objects will be in satisfactory focus from this plane to infinity.” Like Piper, by measuring from the “first focal point” he avoids the need for the $+f$ term in his formula.

Hardy and Perrin conclude from their formulae that “It is evident ... that all objectives have exactly the same depth of field when compared under the same conditions.” This statement only makes sense once you read that what they mean by “under the same conditions” is “a given illumination on the plate” (f -number) and a given “magnification” from the subject to the focal plane (plus, of course, a fixed circle of confusion criterion). What they mean by different objectives (lenses) is different focal lengths, assuming you move your viewpoint to keep the magnification fixed. They also mean to indicate that differences in exit pupil and entrance pupil sizes are unimportant, for a given f -number defined as ratio distance of focal plane from exit pupil to diameter of exit pupil. This is a great relief, since their formulae are all in terms of pupil dimensions, and since their f -number definition is equivalent to our

more simple-minded one. They must have realized, but failed to note, that their “under the same conditions” involved different viewpoint and perspective, different focal length, different aperture diameter, different amount of diffraction blur, and different sensitivity to camera shake.

Hardy and Perrin also echo Abney’s observation when they say “There is, therefore, a great advantage from the standpoint of depth of field in making the smallest possible negative and giving it all the subsequent enlargement that the graininess of the material will permit.” Unlike Abney, however, they fail to note what disadvantages one might encounter by pushing in that direction, or by trying to reduce grain size to allow going further. Essentially, they seem to have missed the point that equal illumination of the plate, with a smaller plate, means less total light, fewer photons, and therefore less image information theoretically available to be captured; at least they recognize that the graininess will therefore be worse with the smaller camera.

Wall’s Dictionary of Photography (Mortimer 1938) has a similar observation: “The much wider lens-aperture, and consequent shorter exposure, permitted by the small camera when so adjusted as to give, on enlargement, prints completely indistinguishable from those from larger negatives, is made very clear...” They don’t seem to recognize that the “much wider lens-aperture” that they’ve used to get an equal depth of field is actually the SAME aperture diameter, and that the higher shutter speed is accompanied by the disadvantage of much higher graininess. This book also includes what is essentially our definition of a “normal” lens: “lenses...used on negatives of the sizes usually associated with them, *i.e.*, when the diagonal of the film is approximately equal to the focal length of the lens.”

The modern tradition of comparing electronic camera formats to 35-mm format was anticipated in 1937 by Beal, who compared a television camera format to a 35-mm movie film format (about 18 x 24 mm) when he said, “The iconoscope mosaic is about 4 by 5 inches, or about six times as large as one 35-mm motion picture frame. Therefore the iconoscope camera lenses are of greater focal length than those employed in motion picture cameras.” He failed to note that if they used the same f -number and degree of correction, such lenses might weigh more by a factor of up to six cubed!

As I said at the start, it was 1939 when Iams et al. wrote that “only the diameter of the lens determines the distance which an object can be moved toward or away from the lens without the image being blurred a given percentage of its height.” This conclusion was based on field of view being held constant. In spite of acceptance of the distinction between depth of field and depth of focus in the optics texts by then, Iams et al. in 1939 still used “Depth of Focus at the object.” Many others similarly continue to use a mix of terminology.

Also in 1939, Henney and Dudley, in their *Handbook of Photography*, took a dualistic approach. Perhaps because of the two authors, they used both “depth of field” and “depth of focus” for the same concept; they used both definitions of hyperfocal distance; they used both feet and inches in their formulae; they used both an approximate near and far distance formula and an adjusted one for close subjects; and they used the symbol f for both the f -number and the focal length. They were nothing if not flexible.

Allen Greenleaf in 1950 takes the expedient of just asserting the formulae for DOF, saying “it can be shown geometrically...” He uses the modern distinction between depth of focus and depth of field, and says, “Knowledge of the depth of focus of his lens is of little practical value to the photographer. It should be noted, however, that some photographers and some writers erroneously use the term *depth of focus* when *depth of field* is meant.” Still true today.

By 1950, the treatment of small formats had been advanced by the analysis of television camera tubes. Weimer, Forgue, and Goodrich wrote:

“Some explanation as to why a smaller pickup tube may require a more sensitive target for equal scene brightness is in order. In the entire tube and optical system are scaled down in size, keeping the same f number lens, the quantity of light in lumens intercepted by the lens is reduced. The output signal of the tube in microamperes is also reduced unless the target sensitivity in microamperes per lumen is increased. On the other hand, if the lens diameter for the small tube were kept the same as for the large tube, no increase in target sensitivity is necessary. However, for the same angle of view this means a faster or lower f number lens. Such lenses, if available at all, are likely to be less highly corrected and more expensive. Thus, in general, the smaller tube will be operated with smaller diameter lenses requiring higher scene brightnesses or more sensitive targets. The gain in depth of field of focus accompanying the use of the smaller diameter lens may, however, be very useful. Motion picture 16-millimeter lenses have been found to be satisfactory.”

To them, the additional DOF (which they called “depth of focus”) of the small format was a consolation prize for getting less light from the scene. Many people still view the “cropped” DSLR formats that way today.

Conclusions

Depth of field is a mature concept that is still widely misunderstood due to complicated derivations and formulae, to parameterizations that obscure more than clarify the dependencies on the situation, and to a general lack of consideration of different formats and their interaction with the choice of COC criteria. I believe an “outside the box” approach to analyzing depth of field helps in understanding these important relationships, especially in the age of digital SLR cameras that share lenses with their larger-format 35 mm film cousins.

References

Anonymous T. H., “Long and Short Focus,” *British Journal of Photography*, XIII 307, p. 138, 1866.

Thomas Sutton and George Dawson, *A Dictionary of Photography*, London: Sampson Low, Son & Marston, 1867, (p. 122).

D. van Monckhoven, *Photographic Optics*, London: Robert Hardwicke, 1867.

John Henry Dallmeyer, *Photographic Lenses: On Their Choice and Use — Special Edition Edited for American Photographers*, pamphlet, 1874.

Ernst Karl Abbe, “Beschreibung eines neuen stereoskopischen Oculars,” *Repertorium für Experimental-Physik, für Physikalische Technik, Mathematische & Astronomische Instrumentenkunde*, Hrsg. von Dr. Philipp Carl, 17, pag. 216–220, 1880.

Sir William de Wiveleslie Abney, *A Treatise on Photography*, first edition, London: Longmans, Green, and Co., 1881 (also 5th edition, 1888, pp. 221–224, and 10th edition, 1905, pp. 275–276).

Leopold Dippel, *Das Mikroskop und seine Anwendung*, zweite umgearbeitete Auflage, erster Theil, Handbuch der allgemeinen Mikroskopie, Braunschweig: Druck und Verlag von Friedrich Vieweg und Sohn, 1882.

Edward L. Wilson, *Wilson's Photographics*, Philadelphia, 1883.

Edward L. Wilson, *Wilson's Quarter Century in Photography*, New York, 1887.

E. J. Wall, *A Dictionary of Photography*, New York: E. & H. T. Anthony & Co., 1889.

C. H. Bothamley, *Ilford Manual of Photography*, London: Britannia Works Co. Ltd., 1891.

W. K. Burton, *Optics for Photographers*, London: Piper & Carter, 1891.

Frederick William Mills, *Photography Applied to the Microscope*, London: Iliffe & Son, 1891.

Thomas R. Dallmeyer, *On the Choice and Use of Photographic Lenses*, pamphlet (expanded reprint of J. H. Dallmeyer's 1874 pamphlet), 1892.

J. Traill Taylor, *The Optics of Photography and Photographic Lenses*, London: Whittaker & Co., 1892.

Siegfried Czapski, *Theorie der optischen Instrumente nach Abbe*, Breslau: Verlag von Eduard Trewendt, 1893.

John A. Hodges, *Photographic Lenses: How to Choose, and How to Use*, Bradford: Percy Lund & Co., 1895.

Thomas R. Dallmeyer, *Telephotography: An elementary treatise on the construction and application of the telephotographic lens*, London: Heinemann, 1899.

Moritz von Rohr, *Theorie Und Geschichte Des Photographischen Objectivs*, Berlin: Verl. von Julius Springer, 1899 (reprinted, Sources of Modern Photography series, New York: Arno Press, 1979).

C. Welborne Piper, *A First Book of the Lens: An Elementary Treatise on the Action and Use of the Photographic Lens*, London: Hazell, Watson, and Viney, Ltd., 1901.

Conrad Beck and Herbert Andrews, *Photographic Lenses: A Simple Treatise*, second edition, London: R. & J. Beck Ltd., c. 1902.

Moritz von Rohr, editor, *Geometrical Investigation of the Formation of Images in Optical Instruments*. London: H. M. Stationery Off., 1920. , Translated by R. Kanthack, from *Die Bilderzeugung in optischen Instrumenten vom Standpunkte der geometrischen Optik*, M. von Rohr, Berlin: J. Springer, 1904.

George Lindsay Johnson, *Photographic Optics and Colour Photography*, London: Ward & Co., 1909.

Alexander Gleichen, *Die Theorie der modernen optischen Instrumente*, Stuttgart: Enke, 1911 (translated by H. H. Emsley and W. Swaine, *The Theory of Modern Optical Instruments*, London: His Majesty's Stationery Office, 1921).

- Bernard E. Jones (ed.), *Cassell's Cyclopaedia of Photography*, London: Cassell, 1911.
- Moritz von Rohr, *Die optischen Instrumente*, Leipzig: B. G. Teubner, 1906 (also 1911).
- James A. Sinclair, *The Sinclair Handbook of Photography*, London: James A. Sinclair & Co, 1913.
- E. J. Wall, *The Dictionary of Photography*, tenth ed., Chicago: Sears, Roebuck, & Co., c.1913.
- R. Child Bayley, *The Complete Photographer*, London: Methuen, revised edition of January 1914.
- Arthur C. Hardy and Fred H. Perrin, *The Principles of Optics*, McGraw-Hill, New York, 1932, pp. 79, 461.
- R. R. Beal, "RCA Developments in Television," *Journal of the Society of Motion Picture Engineers* (reprinted in *Television* vol. II, RCA, 1937).
- F. J. Mortimer (ed.), *Wall's Dictionary of Photography*, 15th ed., "revised and largely rewritten by A. L. M. Sowerby," London, Iliffe & Sons, Ltd., c. 1938.
- Harley Iams, G. A. Morton, and V. K. Zworykin, "The Image Iconoscope" Proc. I.R.E., Sept. 1939 (reprinted in *Television* III, RCA, 1940).
- Keith Henney and Beverly Dudley, *Handbook of Photography*, McGraw Hill, 1939.
- James Mitchell, *The Ilford Manual of Photography*, fourth edition, London: Ilford Ltd., 1949.
- Allen R. Greenleaf, *Photographic Optics*, New York: Macmillan Co., 1950.
- Paul K. Weimer, Stanley V. Forgue, and Robert R. Goodrich, "The Vidicon—Photoconductive Camera Tube," *Electronics*, May, 1950 (reprinted in *Television* Vol. VI, RCA 1952).
- Alan Horder, *The Ilford Manual of Photography*, fifth edition, Essex: Ilford Ltd, 1958.
- Arthur Cox, *Photographic Optics*, 13th edition, London: Focal Press, 1966.
- Alan Horder, *The Manual of Photography*, sixth edition, London: Focal House, 1971.
- Rudolf Kingslake, "Camera Optics," in *Leica Manual*, 15th ed., Douglas O. Morgan, David Vestal, and Willia L. Broecker, editors, Hastings-on-Hudson NY: Morgan & Morgan, 1973.
- Kodak Professional Photoguide*, first edition, Publication No. R-28, Rochester: Eastman Kodak Company, 1975.
- Ralph E. Jacobson, *The Manual of Photography*, seventh edition, London: Focal House, 1978; see chapter "The Geometry of Image Formation" by Sidney F. Ray, pp. 80–83.
- Ted M. Clarke, "Method for Calculating Relative Apertures for Optimizing Diffraction-Limited Depth of Field in Photomacrography," *Microscope*, 32, 219-258, 1984.

H. Lou Gibson, "Depth and Enlarging Factors in Ultra-Close-up and Photomacrographic Prints and Slides," *J. Biological Photography*, 54, 127–141, 1986.

Ralph E. Jacobson, Sidney F. Ray, and Geoffrey G. Attridge, *The Manual of Photography*, eighth edition, Guildford: Focal Press, 1988; see chapter "The Geometry of Image Formation" by Sidney F. Ray, pp. 38–44.

I. T. Young, R. Zagers, L. J. van Vliet, J. Mullikin, F. Boddeke, H. Netten, "Depth-of-Focus in Microscopy," *Proc. of the 8th Scandinavian Conf. on Image Analysis* (Tromsø, Norway, May 25-28), pp. 493–498, Tromsø: Norwegian Society for Image Processing and Pattern Recognition, 1993.

Brian Bracegirdle, *Scientific PhotoMACROgraphy*, Oxford: BIOS Scientific Publishers, 1995.

David M. Jacobson, *Photographic Lenses Tutorial*, <http://www.faqs.org/faqs/rec-photo/lenses/tutorial>, 1995.

David M. Jacobson, *Photographic Lenses FAQ*, <http://www.faqs.org/faqs/rec-photo/lenses/faq>, 1996.

John Delly "Photomacrography," in *Focal Encyclopedia of Photography*, Richard D. Zakia and Leslie Stroebel (eds.), Woburn, MA: Elsevier, 1996.

Kornelius J. Fleischer, editor, "Depth of Field – An Insider's Look Behind The Scenes," *Camera Lens News*, No. 1, <http://www.zeiss.com/C12567A8003B58B9/allBySubject/15C75F926592E5C1C1256CED0054968D>, Oberkochen: Carl Zeiss, Dec. 1997.

Warren Young, *f/Calc Circle of Confusion Help Page*, <http://tangentsoft.net/fcalc/help/CoC.htm>, 2001 (originally at <http://www.cyberport.com/~tangent/photo/fcalc/>, 1998, now accessible through <http://www.archive.org>).

Harold M. Merklinger, *The Ins and Outs of Focus: An Alternative Way to Estimate Depth-of-Field and Sharpness in the Photographic Image*, Internet Edition, <http://www.trenholm.org/hmmerk/download.html> 2002 (original edition 1990).

Douglas A. Kerr, *Depth of Field in Film and Digital Cameras* (online monograph), http://doug.kerr.home.att.net/pumpkin/Depth_of_Field.pdf, Issue 4, Feb., 2004.

Bob Atkins, *Depth of Field and the Digital Domain* (online tutorial), <http://www.photo.net/learn/optics/dofdigital/>, 2003.

Paul van Walree, *Derivation of the DOF Equations* (online article), <http://www.vanwalree.com/optics/dofderivation.html>, 2003.

Norman Koren, *Understanding image sharpness part 6: Depth of field and diffraction*, <http://www.normankoren.com/Tutorials/MTF6.html>, 2005.